

KALİTEYİ ALIŞKANLIK HALİNE GETİRİR...  
MAKING QUALITY A HABIT...

PRODUCT  
CATALOGUE  
**2018**  
ÜRÜN  
KATALOĞU

  
**COMPASS** TRADING

07

Sistem Kablo Kanalları  
Cable Trunkings Systems

22

Aluminyum Kablo  
Kanal Sistemleri  
Aluminium Cable  
Trunking Systems

25

Eco Best Seri  
Kablo Kanalları  
Eco Best Line  
Cable Trunkings

28

Eco Best Seri  
Kendinden Yapışkanlı  
Kablo Kanalları  
Eco Best Line  
Self Adhesive  
Cable Trunkings

30

Döşeme Üstü  
Kablo Kanal Sistemleri  
Overfloor Cable  
Trunking Systems

32

DLX Line Delikli  
Pano Kanalları  
DLX Line  
Slotted Cable  
Trunkings

39

Şebeke, Ups, Data &  
Telefon Prizleri  
Energy, Ups, Data &  
Telephone Sockets

45

Döşeme Altı  
Çıkış Güç Dağıtım  
Kutuları  
Underfloor Power  
Distribution Boxes

50

Dahili 45x45 Modül  
Priz Kutuları/Yapısal  
Kablolama Sistemleri  
45x45 Socket  
Boxes/Structural  
Cabling Systems

51

Ofis Blok  
Sistemleri  
Block Office  
Systems

55

Masa Üstü Priz  
Sistemleri  
Desktop Socket  
Systems

59

Elektrik Tesisat  
Boruları  
Electrical Installation  
Conduits

65

Spiral Borular  
Corrugated Conduits



## ÇEVRE DOSTU ECO FRIENDLY ENVIRONMENT

Çevreye saygılı tasarlanmış ürünler  
Designed products that respect to the environment

DLX tüm tüketici ihtiyaçlarına cevap veren kaliteli çevre dostu ürünler sunar... RoHs\* direktifine uyumlu ürünler.

DLX meet the needs of all consumers by offering high quality eco-friendly products in accordance with RoHs \* directive compliant norms.

Geri dönüşümlü, doğada çözülebilen ambalaj kullanımı.

The use of recycled, biodegradable packaging.

%100 geri dönüşümlü M1 sınıfı orjinal PVC hammadde kullanımı.

100% recycled original M1 class PVC raw material usage.

DLX üretim tesisi ISO 9001 -2008 kalite sertifikası belgelidir.

DLX manufacturing plant is certified by ISO 9001 -2008 quality standards.

"Restriction of Hazardous Substances Directive" (Belirli zararlı maddelerin "ağır metaller" kullanımını kısıtlama) kelimelerinin baş harflerinden oluşur (RoHs)





**Y**ENİLİKÇİ ÜRÜN SİSTEMLERİ  
INNOVATIVE PRODUCT SYSTEMS







AVM'ler

Shopping Malls



Fabrika'lar

Factories



Ofisler

Offices

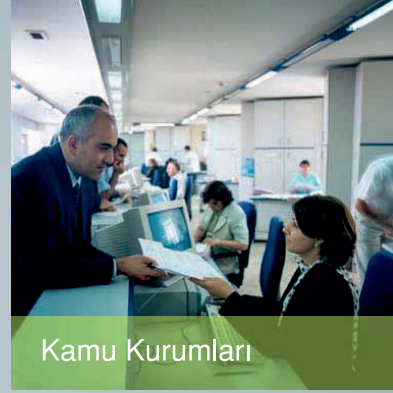

Kamu Kurumları

Public and Government Institutions



Eđitim Kurumları



Sađlık Kurumları





**T**EKNIK ÖZELLİKLER  
TECHNICAL DETAILS







Kimyasal ve Asit buharına dayanımı  
Resistance to chemical and acid steam



Mekanik darbelere dayanıklı.  
Resistance to mechanical shock hits 2 Joule



Alev aldığıında kendiliğinden sönebilen katkı maddeli PVC malzeme (UL94V0 M1).  
Self extinguishing PVC fire reaction (UL94V0 M1)



Ultraviyole ışıklara dayanıklı (UV).  
Resistance to ultraviolet lights (UV).



Boyanabilir.  
Paintable



Kablo kanalları kurşunsuz hammaddeden üretilmektedir.  
Use of unleaded raw materials on cable trunkings

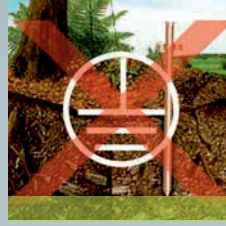

Topraklama gerektirmez  
No need for grounding



İstenilen boyutta kesilebilir.  
Cut down to required size

Özel bir alet gerektirmeden montaj yapılır.  
46-121mm en, 18-50mm derinlik arasında 7 değişik kanal.  
Kanal bağlantı aksesuarları.  
Data ve enerji prizleri takılabilir.  
Ultraviyole ışıklara dayanıklı (UV).  
Koruma sınıfı IP 40.  
Dielektrik dayanımı 270kw/cm değerindedir.  
Kablo kanalları beyaz RAL 9010-9016'dır.  
Karton kutu ambalaja sahiptir.  
Tabanı 46mm üzerinde olan tüm kanallar tam radiuslüdür.  
Döşeme üstü kablo kanalları tam kapaklıdır.

Assembly is done without special tools.  
Trunking measuring from 46 to 121mm wide, from 18 to 50mm depth.  
Full range of fitting and assembling accessories.  
All data, power and sockets can be easily installed.  
Resistant to ultraviolet lights (UV).  
Protection class IP 40.  
Dielectric strength level is 270kw/cm.  
Colours of trunking: White RAL 9010-9016.  
Packaging with carton paper box.  
Cable trunking with more than 46mm base line, have full radius.  
Overfloor cable trunkings have full cover.









**K**ABLO KANAL SİSTEMLERİ  
CABLE TRUNKING SYSTEMS



**COMPASS** TRADING  
"Your COMPASS for Quality.."

# Ref:102 34

## 102 x 34



ET KALINLIĞI **1.8**  
THICKNESS **mm**

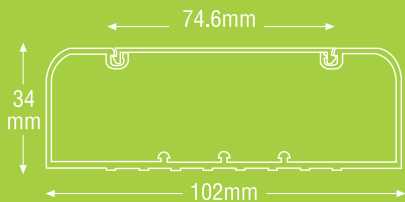
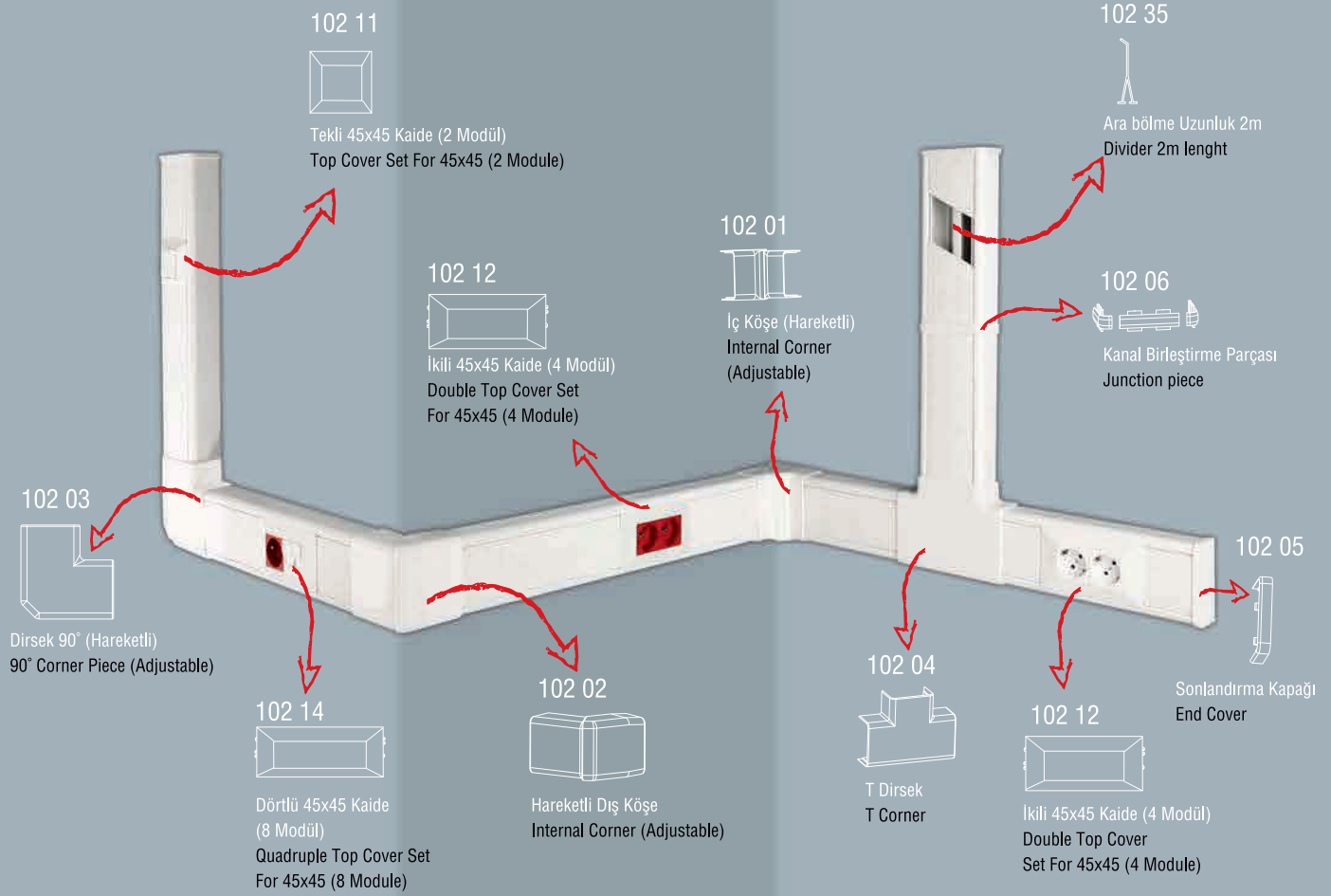

Ambalaj: 24m  
Uzunluk 2m Kesit: 102x34  
Kapaklı satılır. 3 ara bölme takılabilir.  
Renk RAL 9010-9016 Beyaz

Packaging Unit: 24m  
2m length, Dimension: 102x34  
Complete with cover. Up to 3 divider possibility  
Color RAL 9010-9016 White



## MONTAJ TAMAMLAMA AKSESUARLARI / CABLE TRUNKING ACCESSORY LINE



102 01

Ambalaj: 80m  
Ara bölme Uzunluk 2m  
Packaging:80m  
Divider 2m lenght



102 02

Ambalaj: 10 Adet  
İç Köşe (Hareketli)  
Packaging:10 pcs  
Internal Corner (Adjustable)



102 03

Ambalaj: 6 Adet  
Dış Köşe (Hareketli)  
Packaging: 6 pcs  
External Corner (Adjustable)



102 04

Ambalaj: 6 Adet  
Dirsek 90° (Hareketli)  
Packaging:6 pcs  
90° Corner Piece (Adjustable)



102 05

Ambalaj: 8 Adet  
T Dirsek  
Packaging:8 pcs  
T Corner



102 06

Ambalaj: 20 Adet  
Sonlandırma Kapağı  
Packaging:20 pcs  
End Cover



102 07

Ambalaj: 20 Adet  
Kanal Birleştirme Parçası  
Packaging:20 pcs  
Junction piece



102 08

Ambalaj: 20 Adet  
Kablo Tutucu  
Packaging:20 pcs  
Cable Holder

## ANAHTAR PRİZ MONTAJ AKSESUARLARI / SWITCH SOCKET NETWORK ASSEMBLY SET



102 15

Ambalaj: 5 Adet  
İngiliz Tipi Tekli Priz Çerçevesi  
Packaging:5 pcs  
British Type Socket Frame

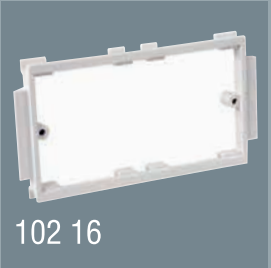

102 16

Ambalaj: 15 Adet  
İngiliz Tipi İkili Priz Çerçevesi  
Packaging:15 pcs  
British Type Double Socket Frame



102 11

Ambalaj: 8 Adet  
Tekli 45x45 Kaide (2 Modül)  
Packaging: 8 pcs  
Top Cover Set For 45x45  
(2 Module)



102 12

Ambalaj: 15 Adet  
İkili 45x45 Kaide (4 Modül)  
Packaging:15 pcs  
Double Top Cover Set For  
45x45 (4 Module)



102 13

Ambalaj: 15 Adet  
Üçlü 45x45 Kaide (6 Modül)  
Packaging:15 pcs  
Triple Top Cover Set For  
45x45 (6 Module)



102 14

Ambalaj: 10 Adet  
Dörtlü 45x45 Kaide (8 Modül)  
Packaging:10 pcs  
Quadruple Top Cover Set For  
45x45 (8 Module)

Ref:102 50  
102 x 50

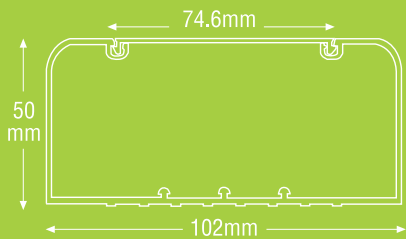
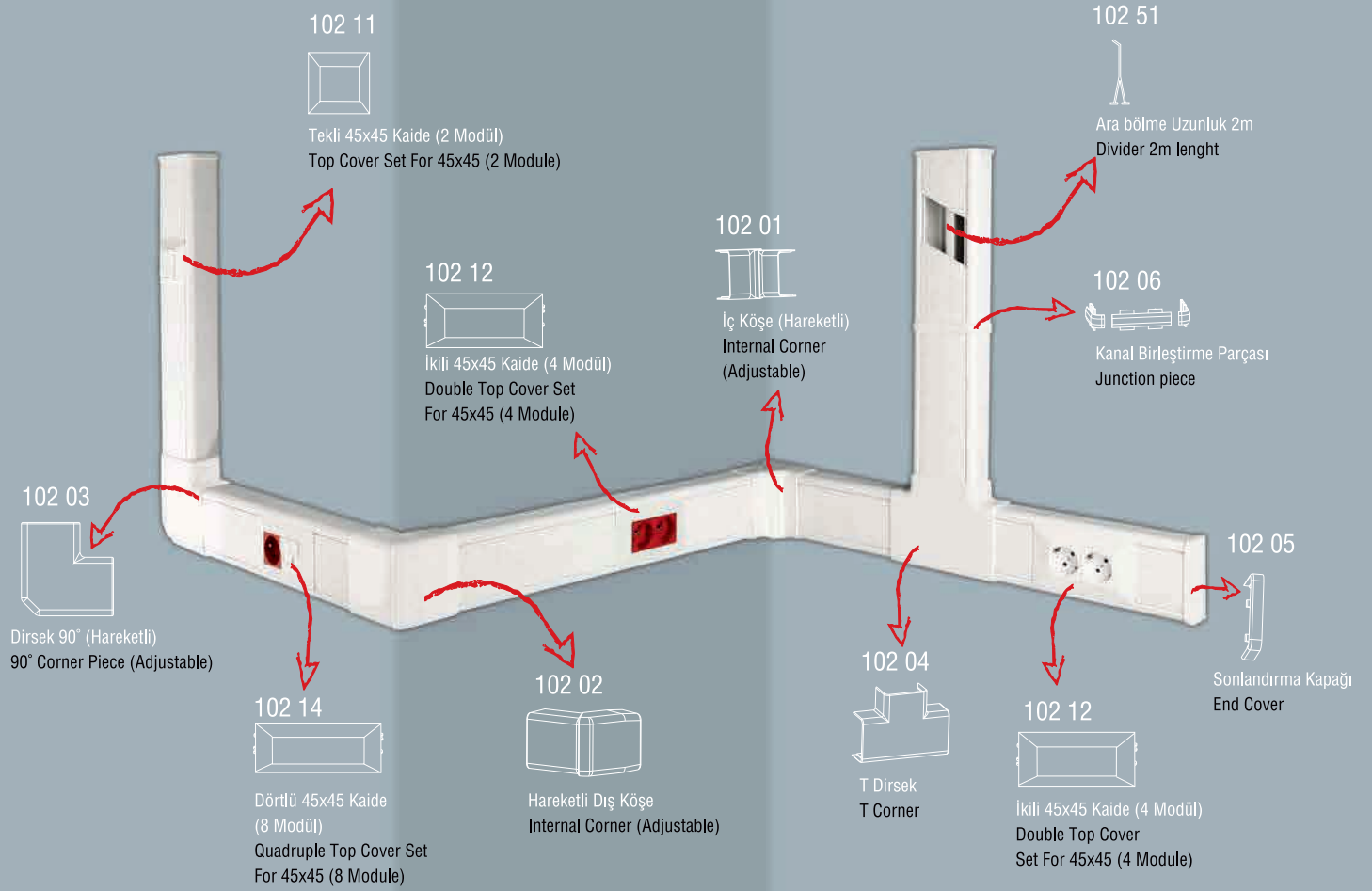

Ambalaj: 16m  
Uzunluk 2m Kesit: 102x50  
Kapaklı satılır. 3 ara bölme takılabilir.  
Renk RAL 9010-9016 Beyaz

Packaging Unit: 16m  
2m length, Dimensions: 102x50  
Complete with cover. Up to 3 divider possibility  
Color RAL 9010-9016 White

**MONTAJ TAMAMLAMA AKSESUARLARI / CABLE TRUNKING ACCESSORY LINE**



102 51

Ambalaj: 50m  
Ara bölme Uzunluk 2m  
Packaging:50m  
Divider 2m length



102 01

Ambalaj: 10 Adet  
İç Köşe (Hareketli)  
Packaging:10 pcs  
Internal Corner (Adjustable)



102 02

Ambalaj: 6 Adet  
Dış Köşe (Hareketli)  
Packaging:6 pcs  
External Corner (Adjustable)



102 03

Ambalaj: 6 Adet  
Dirsek 90° (Hareketli)  
Packaging:6 pcs  
90° Corner Piece (Adjustable)



102 04

Ambalaj: 8 Adet  
T Dirsek  
Packaging:8 pcs  
T Corner



102 05

Ambalaj: 20 Adet  
Sonlandırma Kapağı  
Packaging: 20 pcs  
End Cover

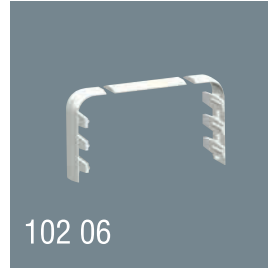

102 06

Ambalaj: 20 Adet  
Kanal Birleştirme Parçası  
Packaging:20 pcs  
Junction piece



102 07

Ambalaj: 20 Adet  
Kablo Tutucu  
Packaging:20 pcs  
Cabra Holder

**ANAHTAR PRİZ MONTAJ AKSESUARLARI / SWITCH SOCKET NETWORK ASSEMBLY SET**



102 15

Ambalaj: 8 Adet  
İngiliz Tipi Tekli Priz Çerçevesi  
Packaging:8 pcs  
British Type Socket Frame



102 16

Ambalaj: 25 Adet  
İngiliz Tipi İkili Priz Çerçevesi  
Packaging:25 pcs  
British Type Double Socket Frame



102 11

Ambalaj: 8 Adet  
Tekli 45x45 Kaide (2 Modül)  
Packaging: 8 pcs  
Top Cover Set For 45x45  
(2 Module)



102 12

Ambalaj: 15 Adet  
İkili 45x45 Kaide (4 Modül)  
Packaging:15 pcs  
Double Top Cover Set For  
45x45 (4 Module)



102 13

Ambalaj: 15 Adet  
Üçlü 45x45 Kaide (6 Modül)  
Packaging:15 pcs  
Triple Top Cover Set For  
45x45 (6 Module)



102 14

Ambalaj: 10 Adet  
Dörtlü 45x45 Kaide (8 Modül)  
Packaging:10 pcs  
Quadruple Top Cover Set For  
45x45 (8 Module)





**COMPASS** TRADING  
"Your COMPASS for Quality.."

Ref:121 50  
**121 x 50**



**ET KALINLIĞI 2.2**  
**THICKNESS mm**

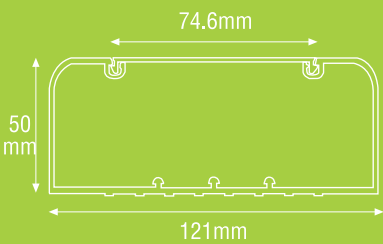
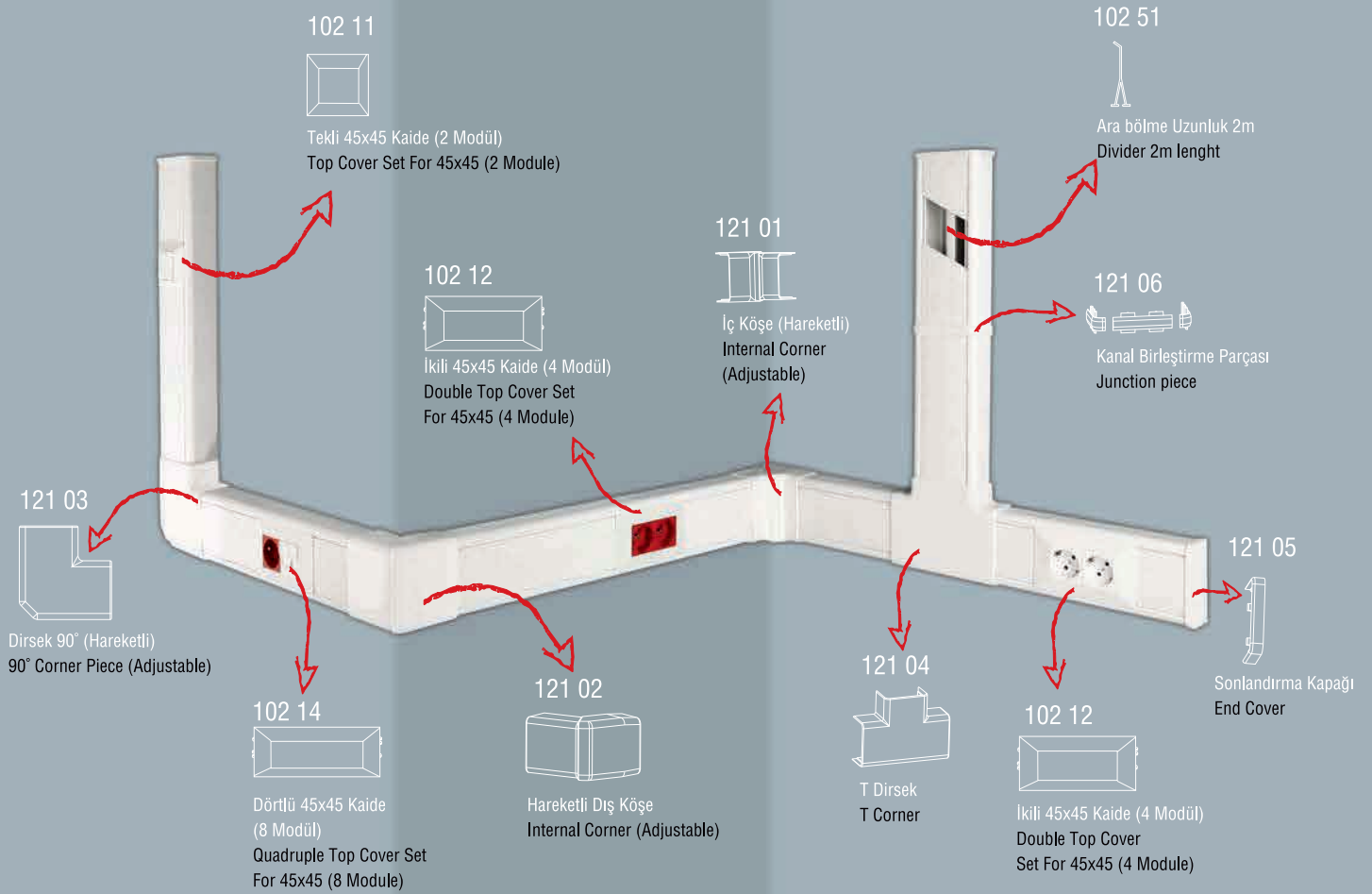

Ambalaj: 16m  
Uzunluk 2m Kesit: 121x50  
Kapaklı satılır. 3 ara bölme takılabilir.  
Renk RAL 9010-9016 Beyaz

Packaging Unit: 16m  
2m length, Dimensions: 121x50  
Complete with cover. Up to 3 divider possibility  
Color RAL 9010-9016 White

## MONTAJ TAMAMLAMA AKSESUARLARI / CABLE TRUNKING ACCESSORY LINE



102 51

Ambalaj: 50m  
Ara bölme Uzunluk 2m  
Packaging: 50m  
Divider 2m length



121 01

Ambalaj: 4 Adet  
İç Köşe (Hareketli)  
Packaging: 4 pcs  
Internal Corner (Adjustable)



121 02

Ambalaj: 4 Adet  
Dış Köşe (Hareketli)  
Packaging: 4 pcs  
External Corner (Adjustable)



121 03

Ambalaj: 4 Adet  
Dirsek 90° (Hareketli)  
Packaging: 4 pcs  
90° Corner Piece (Adjustable)



121 04

Ambalaj: 4 Adet  
T Dirsek  
Packaging: 4 pcs  
T Branches



121 05

Ambalaj: 15 Adet  
Sonlandırma Kapağı  
Packaging: 15 pcs  
End Cover



121 06

Ambalaj: 10 Adet  
Kanal Birleştirme Parçası  
Packaging: 10 pcs  
Junction piece



102 07

Ambalaj: 10 Adet  
Kablo Tutucu  
Packaging: 10 pcs  
Cable Holder

## ANAHTAR PRİZ MONTAJ AKSESUARLARI / SWITCH SOCKET NETWORK ASSEMBLY SET



102 15

Ambalaj: 8 Adet  
İngiliz Tipi Tekli Priz Çerçevesi  
Packaging: 8 pcs  
British Type Socket Frame



102 16

Ambalaj: 25 Adet  
İngiliz Tipi İkili Priz Çerçevesi  
Packaging: 25 pcs  
British Type Double Socket Frame



102 11

Ambalaj: 8 Adet  
Tekli 45x45 Kaide (2 Modül)  
Packaging: 8 pcs  
Top Cover Set For 45x45  
(2 Module)



102 12

Ambalaj: 15 Adet  
İkili 45x45 Kaide (4 Modül)  
Packaging: 15 pcs  
Double Top Cover Set For  
45x45 (4 Module)



102 13

Ambalaj: 15 Adet  
Üçlü 45x45 Kaide (6 Modül)  
Packaging: 15 pcs  
Triple Top Cover Set For  
45x45 (6 Module)



102 14

Ambalaj: 10 Adet  
Dörtlü 45x45 Kaide (8 Modül)  
Packaging: 10 pcs  
Quadruple Top Cover Set For  
45x45 (8 Module)

Ref:85 050  
85 x 50



ET KALINLIĞI 2 mm  
THICKNESS

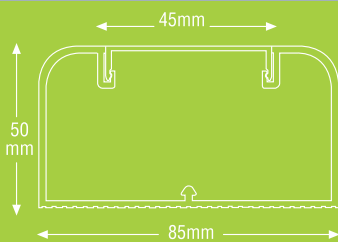
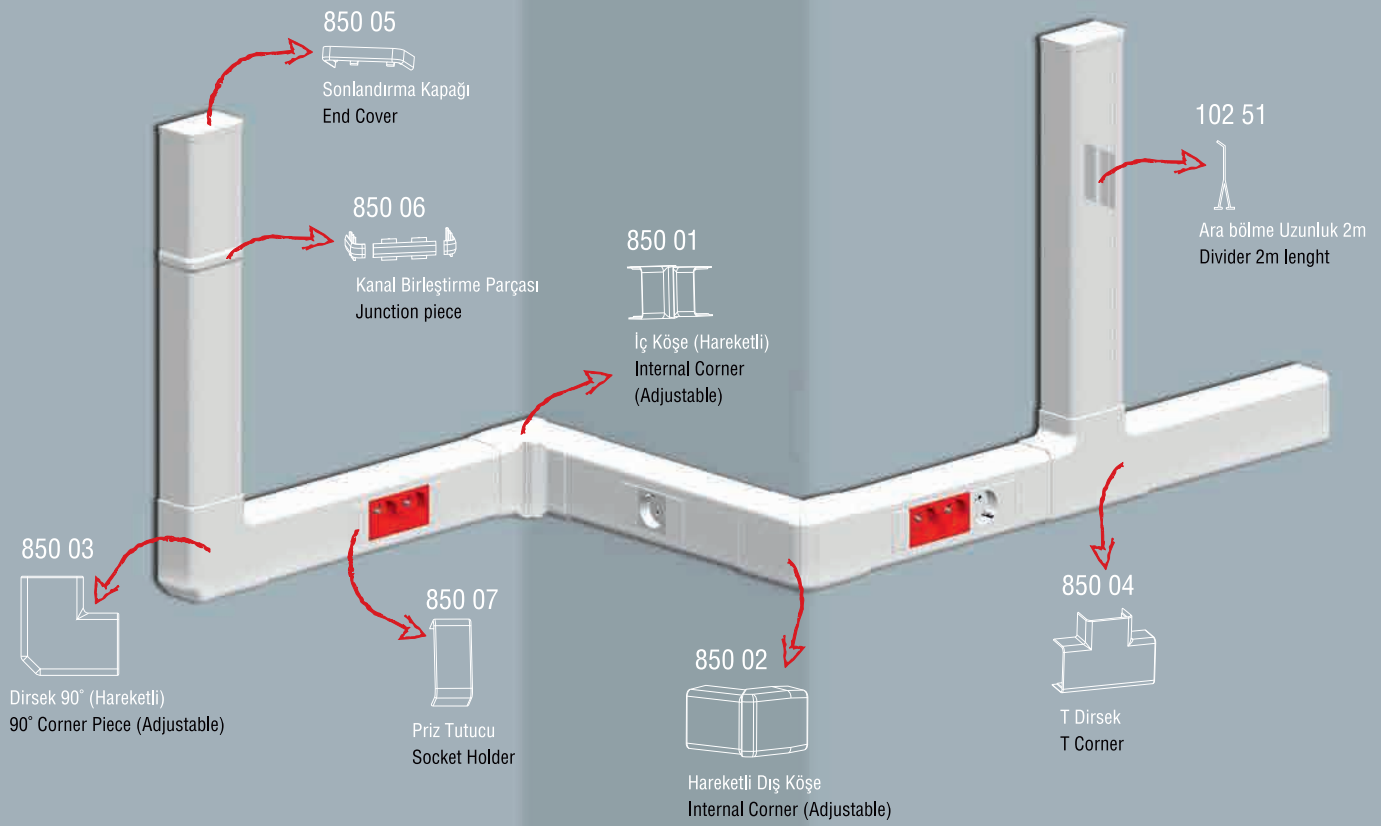

Ambalaj: 16m  
Uzunluk 2m Kesit: 85x50  
Kapaklı satılır.  
Renk RAL 9010-9016 Beyaz

Packaging Unit: 16m  
2m length, Dimensions: 85x50  
Complete with cover.  
Color RAL 9010-9016 White

Kanal üzerine çerçevesiz direk priz montajı  
Frameless socket assembling on cable trunking (Direct socket assembling)



## MONTAJ TAMAMLAMA AKSESUARLARI / CABLE TRUNKING ACCESSORY LINE



Ambalaj: 50m  
Ara bölme Uzunluk 2m  
Packaging:50m  
Divider 2m lenght

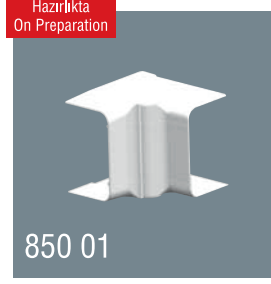

Ambalaj: 5 Adet  
İç Köşe (Hareketli)  
Packaging:5 pcs  
Internal Corner (Adjustable)



Ambalaj: 5 Adet  
Dış Köşe (Hareketli)  
Packaging:5 pcs  
External Corner (Adjustable)



Ambalaj: 5 Adet  
Dirsek 90° (Hareketli)  
Packaging:5 pcs  
90° Corner Piece (Adjustable)



Ambalaj: 5 Adet  
T Dirsek  
Packaging:5 pcs  
T Corner



Ambalaj: 10 Adet  
Sonlandırma Kapağı  
Packaging:10 pcs  
End Cover



Ambalaj: 10 Adet  
Kanal Birleştirme Parçası  
Packaging:10 pcs  
Junction piece



Ambalaj: 10 Adet  
Priz Tutucu  
Packaging:10 pcs  
Socket Holder



Ref:460 18  
46 x 18

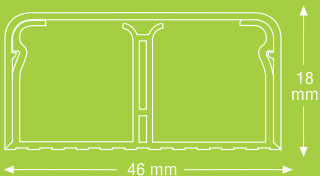
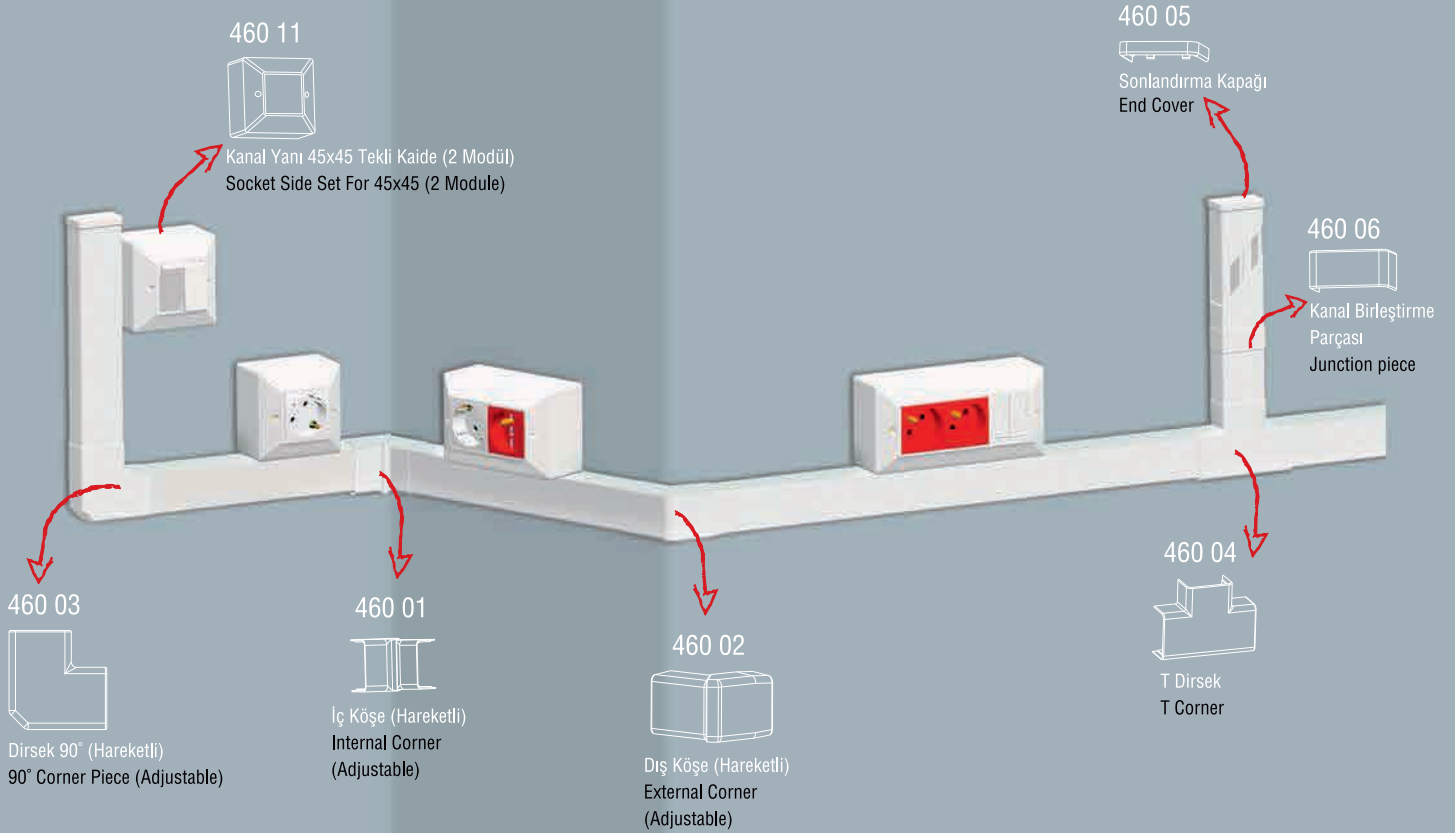
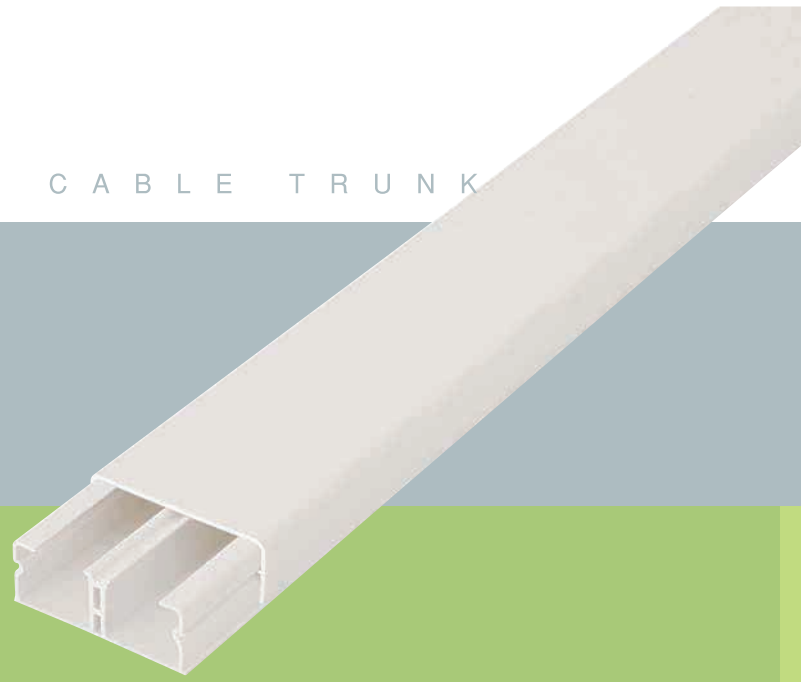

Ambalaj: 60m  
Uzunluk 2m Kesit: 46x18  
Kapaklı satılır. Kendinden bölmelidir.  
Renk RAL 9010-9016 Beyaz

Packaging Unit: 60m  
2m length, Dimensions: 46x18  
Complete with cover. Produced with the separator part.  
Color RAL 9010-9016 White

## MONTAJ TAMAMLAMA AKSESUARLARI / CABLE TRUNKING ACCESSORY LINE



460 01

Ambalaj: 6 Adet  
İç Köşe (Hareketli)  
Packaging:6 pcs  
Internal Corner (Adjustable)



460 02

Ambalaj: 6 Adet  
Dış Köşe (Hareketli)  
Packaging:6 pcs  
External Corner (Adjustable)



460 03

Ambalaj: 6 Adet  
Dirsek 90° (Hareketli)  
Packaging:6 pcs  
90° Corner Piece (Adjustable)



460 04

Ambalaj: 6 Adet  
T Dirsek  
Packaging:6 pcs  
T Corner



460 05

Ambalaj: 50 Adet  
Sonlandırma Kapağı  
Packaging:50 pcs  
End Cover



460 06

Ambalaj: 50 Adet  
Kanal Birleştirme Parçası  
Packaging:50 pcs  
Junction piece



## ANAHTAR PRİZ MONTAJ AKSESUARLARI / SWITCH SOCKET NETWORK ASSEMBLY SET



460 11

Ambalaj: 10 Adet  
Kanal Yanı 45x45 Tekli Kaide  
(2 Modül)  
Packaging:10 pcs  
Socket Side Set For 45x45  
(2 Module)



460 15

Ambalaj: 15 Adet  
Sıvaüstü tekli kasa (universal tip)  
Packaging:15 pcs  
Surface-mounted single box (universal type)

Uygulama / Application

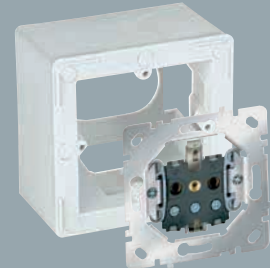



Ref:461 18  
**46 x 18**  
 Bölmesiz  
 (Without Seperator)

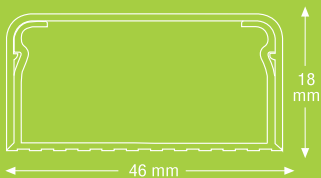
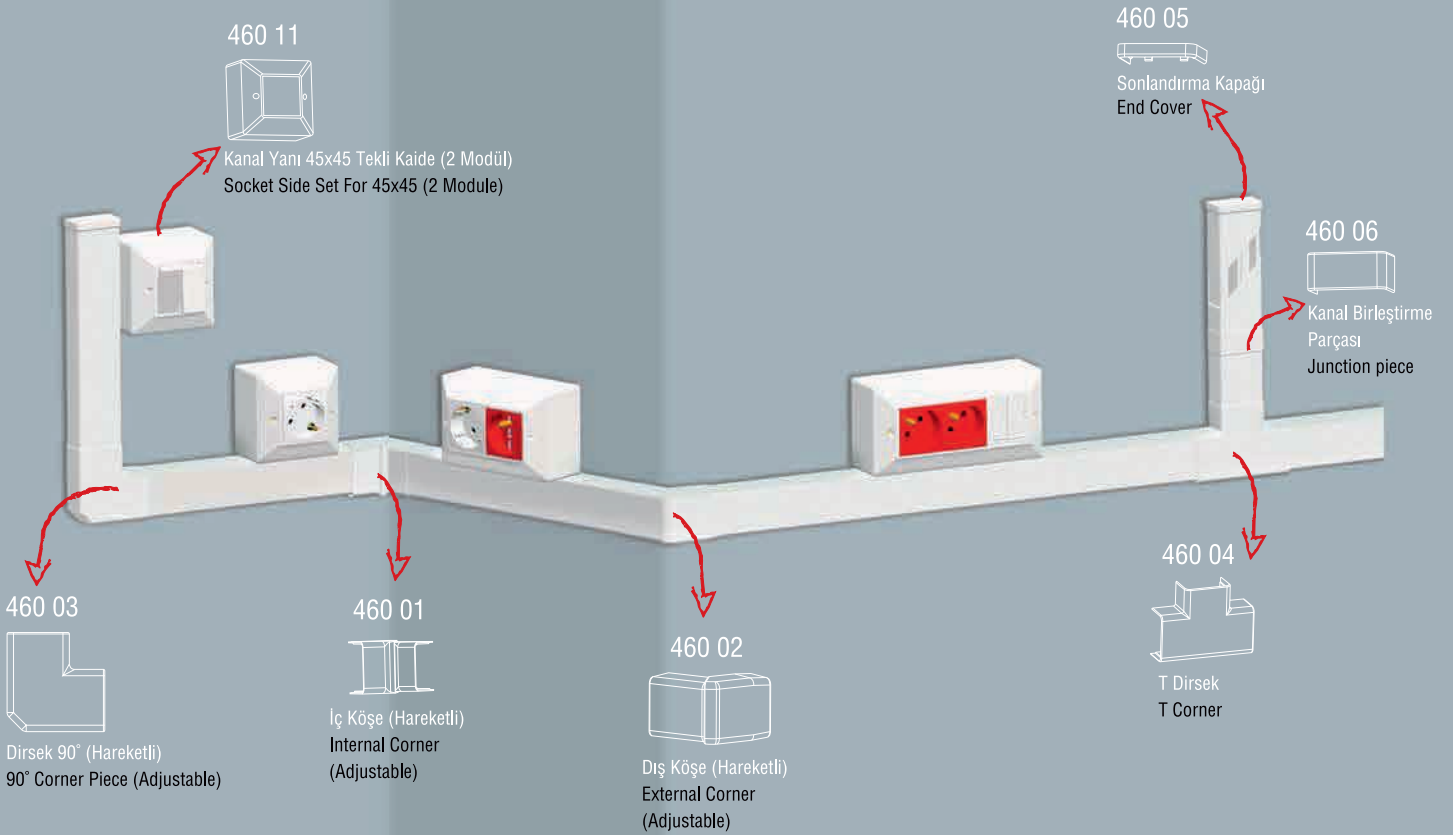
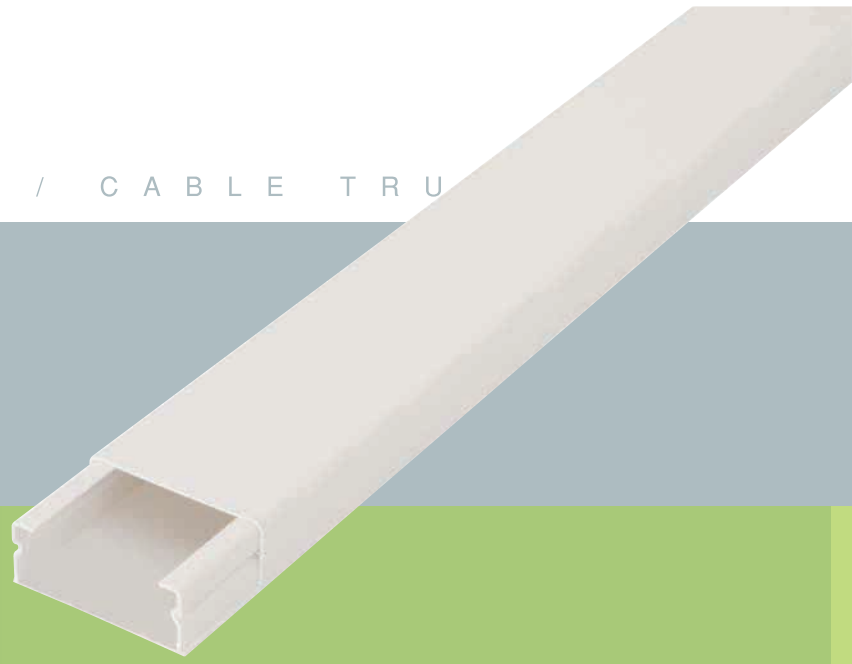

Ambalaj: 60m  
 Uzunluk 2m Kesit: 46x18  
 Kapaklı satılır.  
 Renk RAL 9010-9016 Beyaz

Packaging Unit: 60m  
 2m lenght, Dimensions: 46x18  
 Complete with cover.  
 Color RAL 9010-9016 White

**MONTAJ TAMAMLAMA AKSESUARLARI / CABLE TRUNKING ACCESSORY LINE**



460 01

Ambalaj: 6 Adet  
İç Köşe (Hareketli)  
Packaging: 6 pcs  
Internal Corner (Adjustable)



460 02

Ambalaj: 6 Adet  
Dış Köşe (Hareketli)  
Packaging: 6 pcs  
External Corner (Adjustable)



460 03

Ambalaj: 6 Adet  
Dirsek 90° (Hareketli)  
Packaging: 6 pcs  
90° Corner Piece (Adjustable)



460 04

Ambalaj: 6 Adet  
T Dirsek  
Packaging: 6 pcs  
T Corner



460 05

Ambalaj: 50 Adet  
Sonlandırma Kapağı  
Packaging: 50 pcs  
End Cover



460 06

Ambalaj: 50 Adet  
Kanal Birleştirme Parçası  
Packaging: 50 pcs  
Junction piece



**ANAHTAR PRİZ MONTAJ AKSESUARLARI / SWITCH SOCKET NETWORK ASSEMBLY SET**



460 11

Ambalaj: 10 Adet  
Kanal Yanı 45x45 Tekli Kaide  
(2 Modül)  
Packaging: 10 pcs  
Socket Side Set For 45x45 (2 Module)



460 15

Ambalaj: 10 Adet  
Sıvaüstü tekli kasa (universal tip)  
Packaging: 10 pcs  
Surface-mounted single box (universal type)

Uygulama / Application

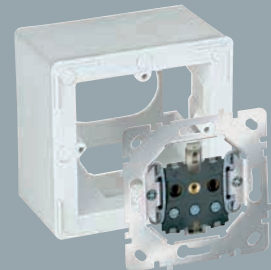

Ref:460 25  
46 x 25

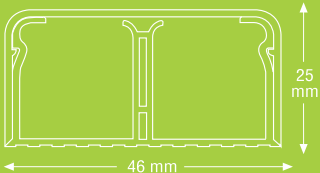
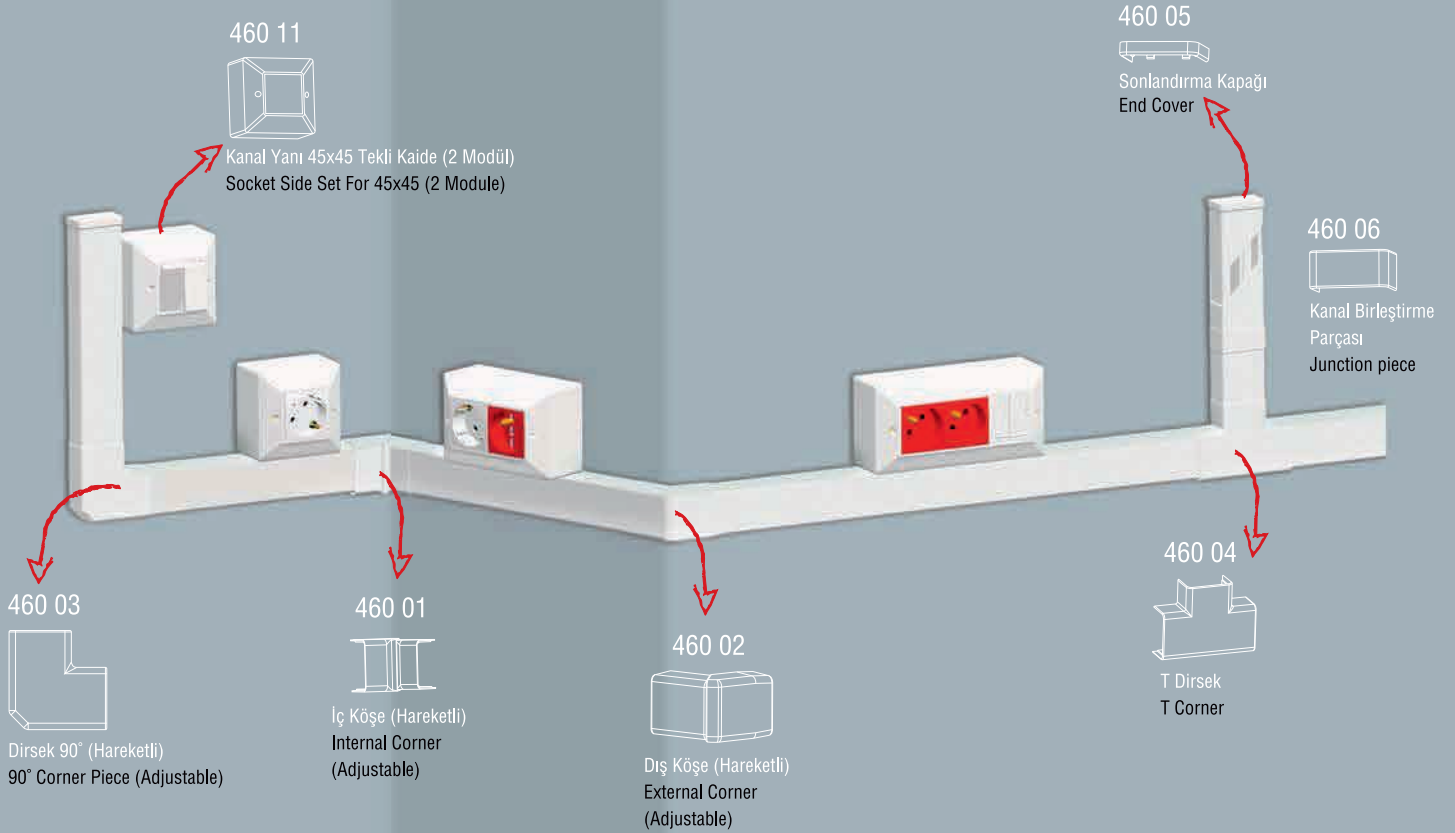
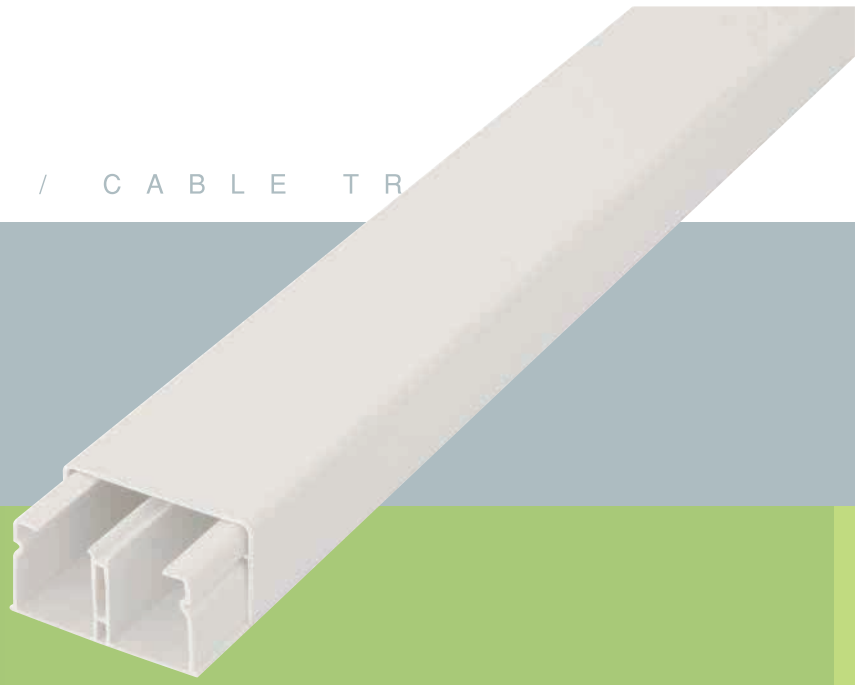

Ambalaj: 50m  
Uzunluk 2m Kesit: 46x25  
Kapaklı satılır. Kendinden bölmelidir.  
Renk RAL 9010-9016 Beyaz

Packaging Unit: 50m  
2m lenght, Dimensions: 46x25  
Complete with cover. Produced with the separator part.  
Color RAL 9010-9016 White



## MONTAJ TAMAMLAMA AKSESUARLARI / CABLE TRUNKING ACCESSORY LINE



460 01

Ambalaj: 6 Adet  
İç Köşe (Hareketli)  
Packaging: 6 pcs  
Internal Corner (Adjustable)



460 02

Ambalaj: 6 Adet  
Dış Köşe (Hareketli)  
Packaging: 6 pcs  
External Corner (Adjustable)



460 03

Ambalaj: 6 Adet  
Dirsek 90° (Hareketli)  
Packaging: 6 pcs  
90° Corner Piece (Adjustable)



460 04

Ambalaj: 6 Adet  
T Dirsek  
Packaging: 6 pcs  
T Corner



460 05

Ambalaj: 50 Adet  
Sonlandırma Kapağı  
Packaging: 50 pcs  
End Cover



460 06

Ambalaj: 50 Adet  
Kanal Birleştirme Parçası  
Packaging: 50 pcs  
Junction piece



## ANAHİTAR PRİZ MONTAJ AKSESUARLARI / SWITCH SOCKET NETWORK ASSEMBLY SET



460 11

Ambalaj: 10 Adet  
Kanal Yanı 45x45 Tekli Kaide  
(2 Modül)  
Packaging: 10 pcs  
Socket Side Set For 45x45 (2 Module)



460 15

Ambalaj: 10 Adet  
Sıvaüstü tekli kasa (universal tip)  
Packaging: 10 pcs  
Surface-mounted single box (universal type)

Uygulama / Application

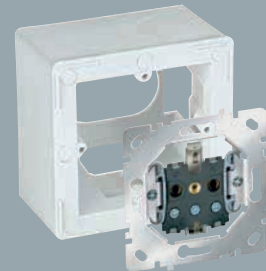

## METALİK GRİ BOYALI KABLO KANAL SİSTEMLERİ/METALIC GREY PAINTING CABLE TRUNKING SYSTEMS

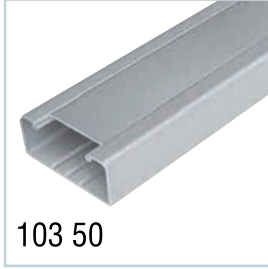

103 50

Ambalaj: 16 m  
102x50 Alüminyum Kablo Kanalı  
Packaging:16 m  
Aluminium Cable Trunking

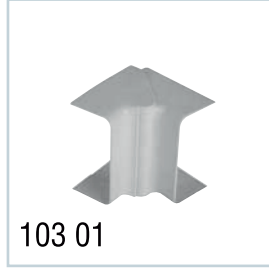

103 01

Ambalaj: 10 Adet  
İç Köşe (Hareketli)  
Packaging:10 pcs  
Internal Corner (Adjustable)



103 02

Ambalaj: 6 Adet  
Dış Köşe (Hareketli)  
Packaging:6 pcs  
External Corner (Adjustable)

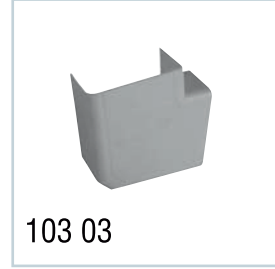

103 03

Ambalaj: 6 Adet  
Dirsek 90° (Hareketli)  
Packaging:6 pcs  
90° Corner Piece (Adjustable)

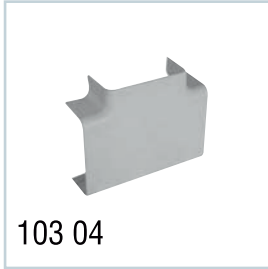

103 04

Ambalaj: 8 Adet  
T Dirsek  
Packaging:8 pcs  
T Corner

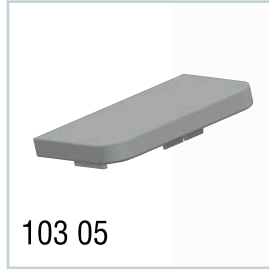

103 05

Ambalaj: 20 Adet  
Sonlandırma Kapağı  
Packaging: 20 pcs  
End Cover

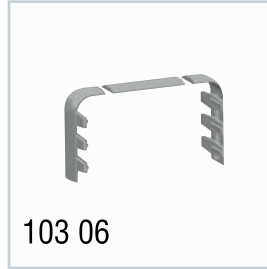

103 06

Ambalaj: 20 Adet  
Kanal Birleştirme Parçası  
Packaging:20 pcs  
Junction piece



102 51

Ambalaj: 50m  
Ara bölme Uzunluk 2m  
Packaging:50m  
Divider 2m length



103 07

Ambalaj: 20 Adet  
Kablo Tutucu  
Packaging:20 pcs  
Cable Holder



Kanalları istediğiniz renk seçeneklerinde boyanabilir.  
Can be painted with the color you choose

## ANAHTAR PRİZ MONTAJ AKSESUARLARI / SWITCH SOCKET NETWORK ASSEMBLY SET

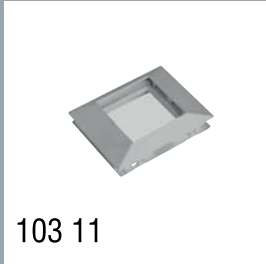

103 11

Ambalaj: 8 Adet  
Tekli 45x45 Kaide (2 Modül)  
Packaging:8 pcs  
Top Cover Set For 45x45  
(2 Module)



103 12

Ambalaj: 15 Adet  
İkili 45x45 Kaide (4 Modül)  
Packaging:15 pcs  
Double Top Cover Set For  
45x45 (4 Module)



103 13

Ambalaj: 15 Adet  
Üçlü 45x45 Kaide (6 Modül)  
Packaging:15 pcs  
Triple Top Cover Set For  
45x45 (6 Module)



103 14

Ambalaj: 10 Adet  
Dörtlü 45x45 Kaide (8 Modül)  
Packaging:10 pcs  
Quadruple Top Cover Set For  
45x45 (8 Module)

Not: Aksesuarlar metalik boyalı ABS'dir  
Note: Accessories are made of colored ABS Plastic raw material.

# ALLUMINYUM KABLO KANAL SİSTEMLERİ ALLUMINIUM CABLE TRUNKING SYSTEMS

Ref:104 50  
100 x 50

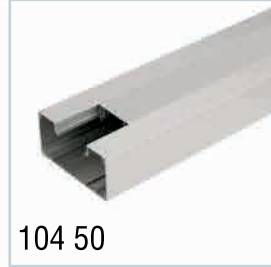
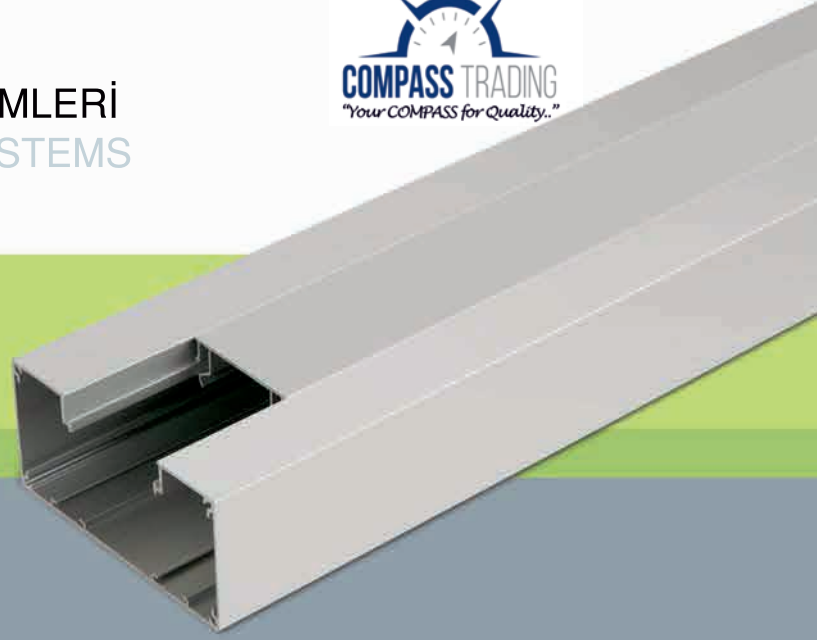

104 50

Ambalaj: 16 m  
104x50 Alüminyum Kablo Kanalı  
Packaging: 16 m  
Aluminium Cable Trunking

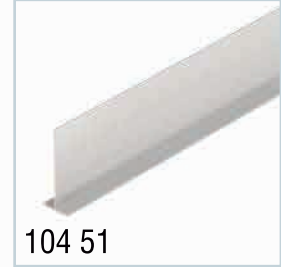

104 51

Ambalaj: 50m  
Ara bölme Uzunluk 2m  
Packaging: 50m  
Divider 2m length



104 01

İç Köşe (Hareketli)  
Internal Corner (Adjustable)

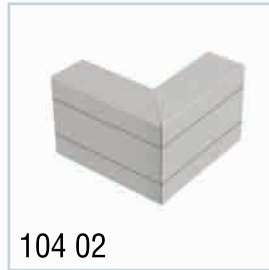

104 02

Dış Köşe (Hareketli)  
External Corner (Adjustable)



104 03

Dirsek 90° (Hareketli)  
90° Corner Piece (Adjustable)



104 04

T Dirsek  
T Corner

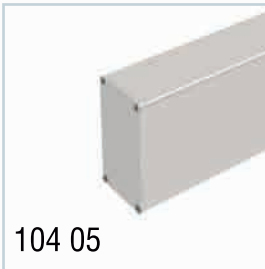

104 05

Sonlandırma Kapağı  
End Cover



104 08

Dörtlü Dirsek  
Quadro Corner



104 09

Yatay Birleştirme Parçası  
Horizontal Junction Piece



104 10

Dikey Birleştirme Parçası  
Vertical Junction Piece

Kanal üzerine çerçevesiz direk priz montajı  
Frameless socket assembling on cable trunking (Direct socket assembling)

Ref:105 50  
105 x 50



Ambalaj: 16m  
Uzunluk 2m Kesit: 102x50  
Kapaklı satılır. 3 ara bölme takılabilir.  
Renk RAL 9010-9016 Beyaz  
Packaging Unit: 16m  
2m length, Dimensions: 102x50  
Complete with cover. Up to 3 divider possibility  
Color RAL 9010-9016 White

### MONTAJ TAMAMLAMA AKSESUARLARI / CABLE TRUNKING ACCESSORY LINE



105 51

Ambalaj: 50m  
HF Ara bölme Uzunluk 2m  
Packaging:50m  
Divider 2m length

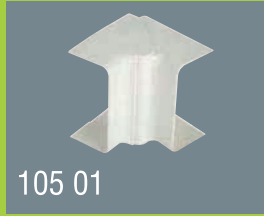

105 01

Ambalaj: 10 Adet  
HF İç Köşe (Hareketli)  
Packaging:10 pcs  
Internal Corner (Adjustable)



105 02

Ambalaj: 6 Adet  
HF Dış Köşe (Hareketli)  
Packaging:6 pcs  
External Corner (Adjustable)



105 03

Ambalaj: 6 Adet  
HF Dirsek 90° (Hareketli)  
Packaging:6 pcs  
90° Corner Piece (Adjustable)



105 04

Ambalaj: 8 Adet  
HF T Dirsek  
Packaging:8 pcs  
T Corner



105 05

Ambalaj: 20 Adet  
HF Sonlandırma Kapağı  
Packaging: 20 pcs  
End Cover



105 06

Ambalaj: 20 Adet  
HF Kanal Birleştirme Parçası  
Packaging:20 pcs  
Junction piece



105 07

Ambalaj: 20 Adet  
HF Kablo Tutucu  
Packaging:20 pcs  
Cable Holder

### ANAHTAR PRİZ MONTAJ AKSESUARLARI / SWITCH SOCKET NETWORK ASSEMBLY SET



105 15

Ambalaj: 8 Adet  
HF İngiliz Tipi Tekli Priz Çerçevesi  
Packaging:8 pcs  
British Type Socket Frame



105 16

Ambalaj: 25 Adet  
HF İngiliz Tipi İkili Priz Çerçevesi  
Packaging:25 pcs  
British Type Double Socket Frame



105 11

Ambalaj: 8 Adet  
HF Tekli 45x45 Kaide (2 Modül)  
Packaging: 8 pcs  
Top Cover Set For 45x45  
(2 Module)



105 12

Ambalaj: 15 Adet  
HF İkili 45x45 Kaide (4 Modül)  
Packaging:15 pcs  
Double Top Cover Set For  
45x45 (4 Module)

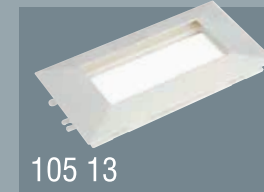

105 13

Ambalaj: 15 Adet  
HF Üçlü 45x45 Kaide (6 Modül)  
Packaging:15 pcs  
Triple Top Cover Set For  
45x45 (6 Module)



105 14

Ambalaj: 10 Adet  
HF Dörtlü 45x45 Kaide (8 Modül)  
Packaging:10 pcs  
Quadruple Top Cover Set For  
45x45 (8 Module)



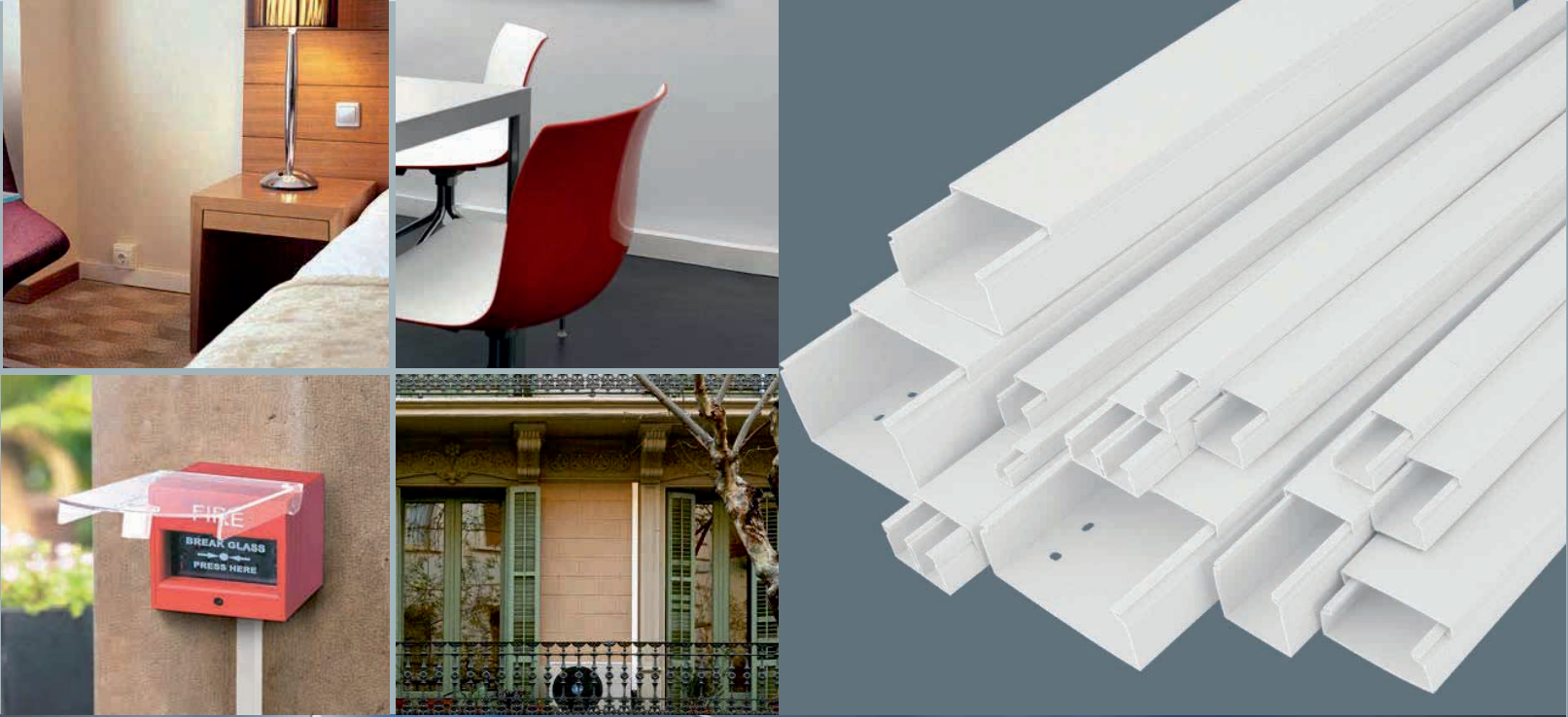

**E**KO BEST SERİ KABLO KANALLARI  
ECO BEST LINE CABLE TRUNKING



**COMPASS** TRADING

*"Your COMPASS for Quality.."*



## EKO BEST SERİ KABLO KANALLARI / ECO BEST LINE CABLE TRUNKING

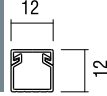

125 12

**12x12**

PVC Kablo Kanalı  
Kapaklı Satılır  
Ambalaj: 340m / 170 Boy  
12x12 PVC Cable Trunking  
Complete with cover  
Packaging: 340m / 170 Pcs

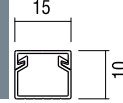

156 10

**15x10**

PVC Kablo Kanalı  
Kapaklı Satılır  
Ambalaj: 364m / 182 Boy  
15x10 PVC Cable Trunking  
Complete with cover  
Packaging: 364m / 182 Pcs

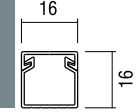

165 16

**16x16**

PVC Kablo Kanalı  
Kapaklı Satılır  
Ambalaj: 192m / 96 Boy  
16x16 PVC Cable Trunking  
Complete with cover  
Packaging: 192m / 96 Pcs

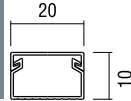

205 10

**20x10**

PVC Kablo Kanalı  
Kapaklı Satılır  
Ambalaj: 260m / 130 Boy  
20x10 PVC Cable Trunking  
Complete with cover  
Packaging: 260m / 130 Pcs

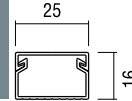

255 16

**25x16**

PVC Kablo Kanalı  
Kapaklı Satılır  
Ambalaj: 128m / 64 Boy  
25x16 PVC Cable Trunking  
Complete with cover  
Packaging: 128m / 64 Pcs

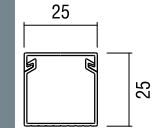

255 25

**25x25**

PVC Kablo Kanalı  
Kapaklı Satılır  
Ambalaj: 80m / 40 Boy  
25x25 PVC Cable Trunking  
Complete with cover  
Packaging: 80m / 40 Pcs

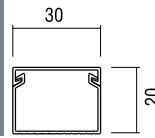

305 20

**30x20**

PVC Kablo Kanalı  
Kapaklı Satılır  
Ambalaj: 84m / 42 Boy  
30x20 PVC Cable Trunking  
Complete with cover  
Packaging: 84m / 42 Pcs



Hazırlıkta  
On Preparation

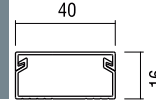

405 16

**40x16**

PVC Kablo Kanalı  
Kapaklı Satılır  
Ambalaj: 60m / 30 Boy  
40x16 PVC Cable Trunking  
Complete with cover  
Packaging: 60m / 30 Pcs

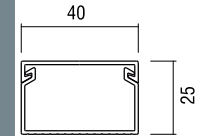

405 25

**40x25**

PVC Kablo Kanalı  
Kapaklı Satılır  
Ambalaj: 50m / 25 Boy  
40x25 PVC Cable Trunking  
Complete with cover  
Packaging: 50m / 25 Pcs

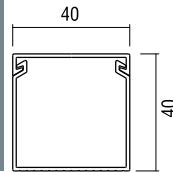

405 40

**40x40**

PVC Kablo Kanalı  
Kapaklı Satılır  
Ambalaj: 48m / 24 Boy  
40x40 PVC Cable Trunking  
Complete with cover  
Packaging: 48m / 24 Pcs

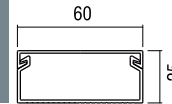

605 25

**60x25**

PVC Kablo Kanalı  
Kapaklı Satılır  
Ambalaj: 48m / 24 Boy  
60x25 PVC Cable Trunking  
Complete with cover  
Packaging: 48m / 24 Pcs

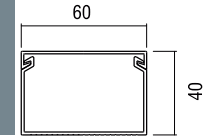

605 40

**60x40**

PVC Kablo Kanalı  
Kapaklı Satılır  
Ambalaj: 36m / 18 Boy  
60x40 PVC Cable Trunking  
Complete with cover  
Packaging: 36m / 18 Pcs

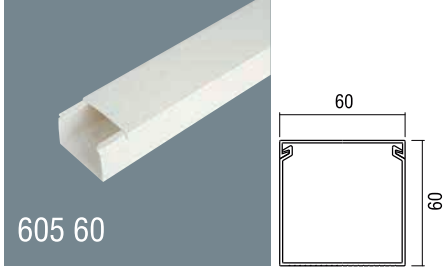

**60x60**  
PVC Kablo Kanalı  
Kapaklı Satılır  
Ambalaj: 24m / 12 Boy  
60x60 PVC Cable Trunking  
Complete with cover  
Packaging: 24m / 12 Pcs

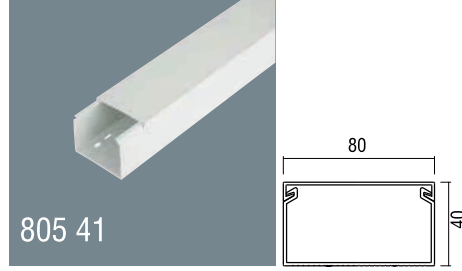

**80x40**  
PVC Kablo Kanalı  
Kapaklı Satılır  
Ambalaj: 28m / 14 Boy  
80x40 PVC Cable Trunking  
Complete with cover  
Packaging: 28m / 14 Pcs

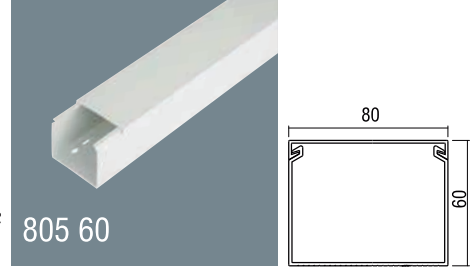

**80x60**  
PVC Kablo Kanalı  
Kapaklı Satılır  
Ambalaj: 24m / 12 Boy  
80x60 PVC Cable Trunking  
Complete with cover  
Packaging: 24m / 12 Pcs

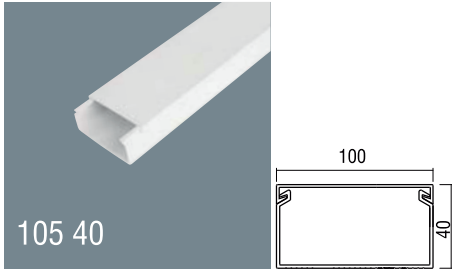

**100x40**  
PVC Kablo Kanalı  
Kapaklı Satılır  
Ambalaj: 20m / 10 Boy  
100x40 PVC Cable Trunking  
Complete with cover  
Packaging: 20m / 10 Pcs

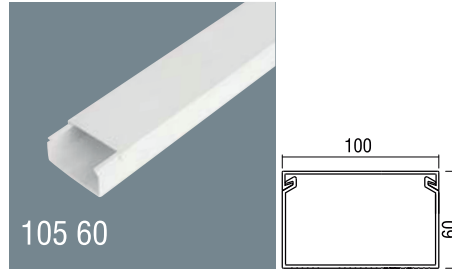

**100x60**  
PVC Kablo Kanalı  
Kapaklı Satılır  
Ambalaj: 16m / 8 Boy  
100x60 PVC Cable Trunking  
Complete with cover  
Packaging: 16m / 8 Pcs

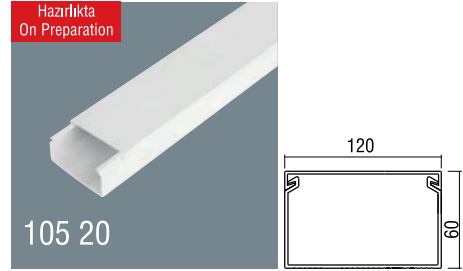

**120x60**  
PVC Kablo Kanalı  
Kapaklı Satılır  
Ambalaj: 16m / 8 Boy  
120x60 PVC Cable Trunking  
Complete with cover  
Packaging: 16m / 8 Pcs

## BOYALI EKO BEST SERİ KABLO KANALLARI PAINTING ECO BEST LINE CABLE TRUNKING

- Huş  
Birch
- Meşe  
Oak
- Ceviz  
Walnut



**16x16 • 25x16 • 25x25 • 40x25 • 102x50**  
Kanal ebatlarımızı istediğiniz renk seçeneklerinde boyanabilir.

**16x16 • 25x16 • 25x25 • 40x25 • 102x50**  
Sizes can be painted with the color you choose

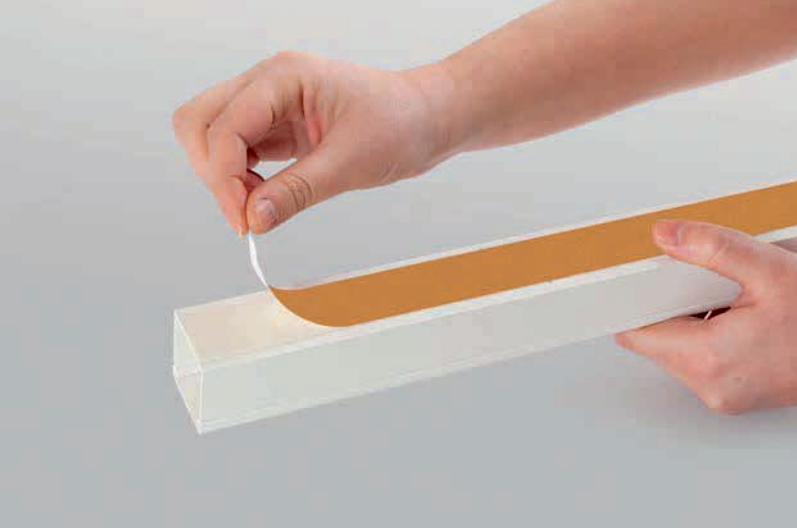
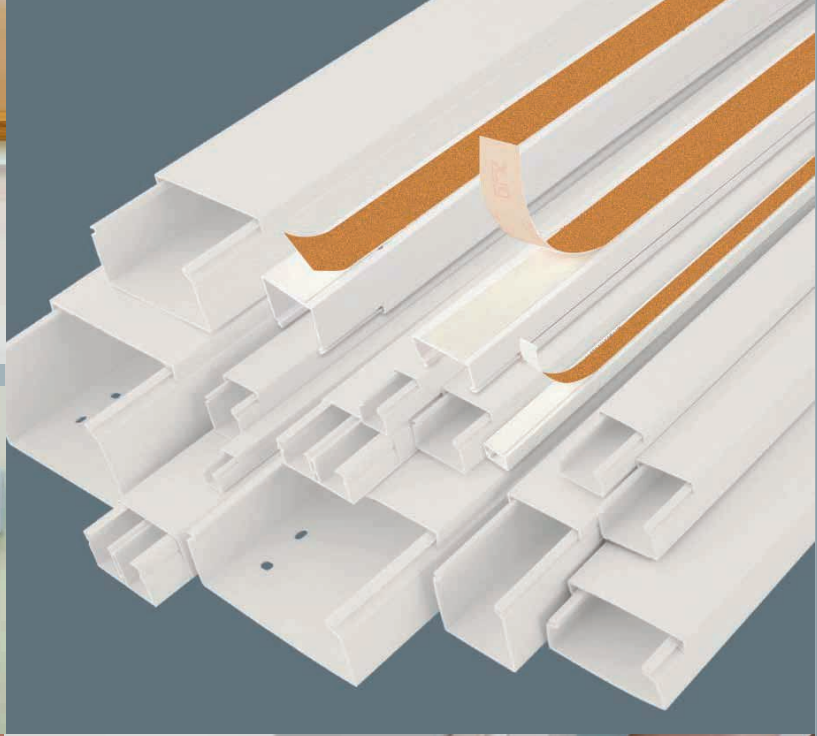

**E**KO BEST SERİ KENDİNDEN YAPIŞKANLI KABLO KANALLARI  
ECO BEST LINE SELF ADHESIVE CABLE TRUNKINGS



**COMPASS** TRADING  
"Your COMPASS for Quality.."

**EKO BEST SERİ KENDİNDEN YAPIŞKANLI KABLO KANALLARI**  
**ECO BEST LINE SELF ADHESIVE CABLE TRUNKINGS**

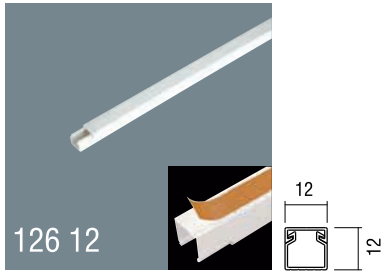

**12x12**  
PVC Yapışkan Bantlı Kablo Kanalı  
Kapaklı Satılır  
Ambalaj: 340m / 170 Boy  
12x12 Self Adhesive PVC Cable Trunking  
With cover  
Packaging: 340m / 170 Pcs

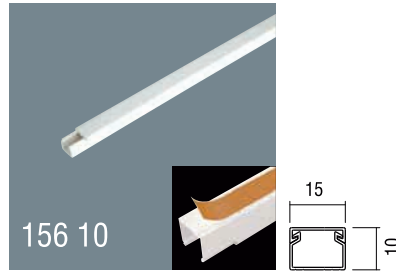

**15x10**  
PVC Yapışkan Bantlı Kablo Kanalı  
Kapaklı Satılır  
Ambalaj: 364m / 182 Boy  
15x10 Self Adhesive PVC Cable Trunking  
With cover  
Packaging: 364m / 182 Pcs

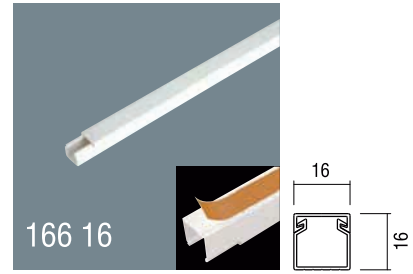

**16x16**  
PVC Yapışkan Bantlı Kablo Kanalı  
Kapaklı Satılır  
Ambalaj: 192m / 96 Boy  
16x16 Self Adhesive PVC Cable Trunking  
With cover  
Packaging: 192m / 96 Pcs

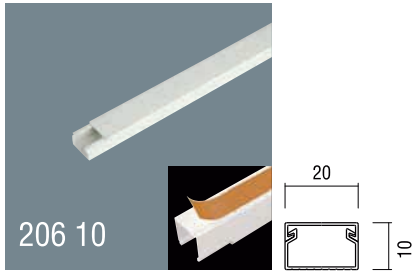

**20x10**  
PVC Yapışkan Bantlı Kablo Kanalı  
Kapaklı Satılır  
Ambalaj: 260m / 130 Boy  
20x10 Self Adhesive PVC Cable Trunking  
With cover  
Packaging: 260m / 130 Pcs

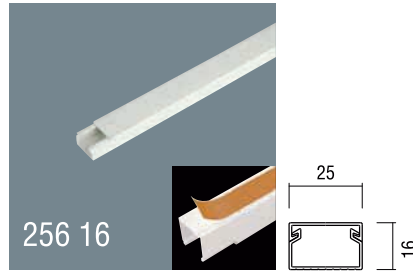

**25x16**  
PVC Yapışkan Bantlı Kablo Kanalı  
Kapaklı Satılır  
Ambalaj: 128m / 64 Boy  
25x16 Self Adhesive PVC Cable Trunking  
With cover  
Packaging: 128m / 64 Pcs

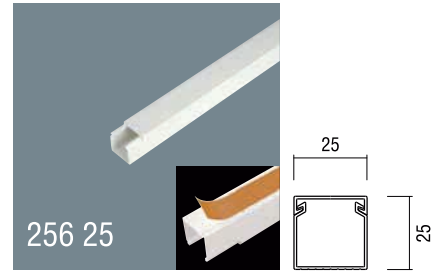

**25x25**  
PVC Yapışkan Bantlı Kablo Kanalı  
Kapaklı Satılır  
Ambalaj: 80m / 40 Boy  
25x25 Self Adhesive PVC Cable Trunking  
With cover  
Packaging: 80m / 40 Pcs

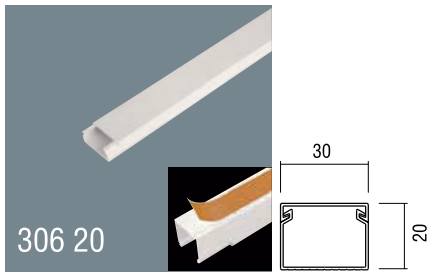

**30x20**  
PVC Yapışkan Bantlı Kablo Kanalı  
Kapaklı Satılır  
Ambalaj: 84m / 42 Boy  
30x20 Self Adhesive PVC Cable Trunking  
With cover  
Packaging: 84m / 42 Pcs

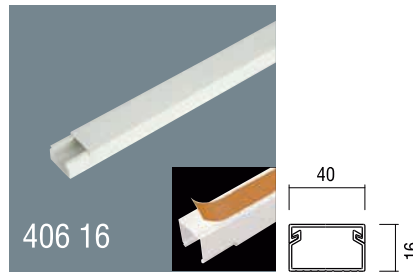

**40x16**  
PVC Yapışkan Bantlı Kablo Kanalı  
Kapaklı Satılır  
Ambalaj: 60m / 30 Boy  
40x16 Self Adhesive PVC Cable Trunking  
With cover  
Packaging: 60m / 30 Pcs

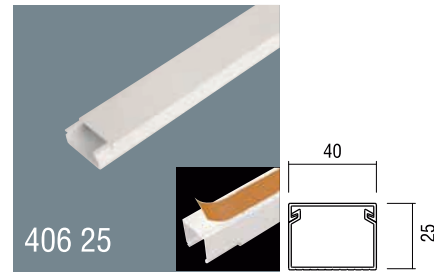

**40x25**  
PVC Yapışkan Bantlı Kablo Kanalı  
Kapaklı Satılır  
Ambalaj: 50m / 25 Boy  
40x25 Self Adhesive PVC Cable Trunking  
With cover  
Packaging: 50m / 25 Pcs

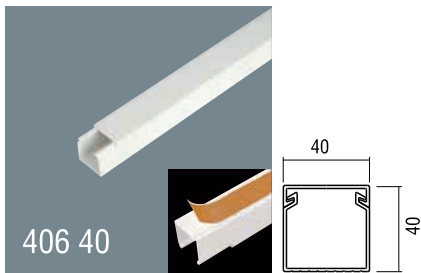

**40x40**  
PVC Yapışkan Bantlı Kablo Kanalı  
Kapaklı Satılır  
Ambalaj: 48m / 24 Boy  
40x40 Self Adhesive PVC Cable Trunking  
With cover  
Packaging: 48m / 24 Pcs

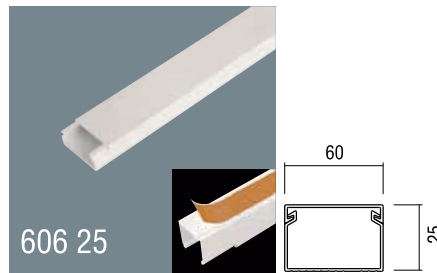

**60x25**  
PVC Yapışkan Bantlı Kablo Kanalı  
Kapaklı Satılır  
Ambalaj: 48m / 24 Boy  
60x25 Self Adhesive PVC Cable Trunking  
With cover  
Packaging: 48m / 18 Pcs

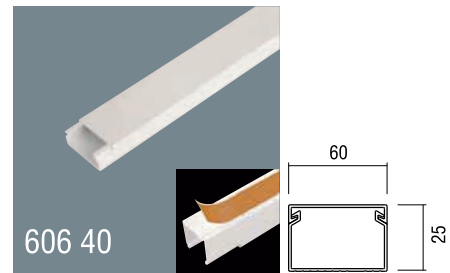

**60x40**  
PVC Yapışkan Bantlı Kablo Kanalı  
Kapaklı Satılır  
Ambalaj: 36m / 18 Boy  
60x40 Self Adhesive PVC Cable Trunking  
With cover  
Packaging: 36m / 18 Pcs





**D**ÖŞEME ÜSTÜ KABLO KANAL SİSTEMLERİ  
OVERFLOOR CABLE TRUNKING SYSTEMS



## DÖŞEMEÜSTÜ KABLO KANALLARI OVERFLOOR CABLE TRUNKS SYSTEMS



520 12

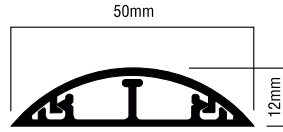

**50x12**

PVC Kanal / PVC Trunk  
Uzunluk 2m / Length 2m  
Ambalaj: 72m / Packaging: 72m  
Kesit 50x12mm / Size 50x12mm  
Kapaklı Satılır / Complete with cover  
Kendinden Ara Bölmeli / Produced with self-separator Part  
Renk RAL 7023 Gri / Grey Color RAL 7023

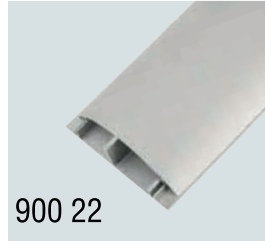

900 22

**ALUMİNYUM  
ALUMINIUM**

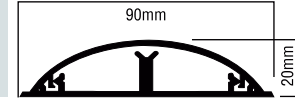

**90x20**

Aluminyum Kanal / Alluminium Trunk  
Uzunluk 2m / Length 2m  
Ambalaj: 24m / Packaging: 24m  
Kesit 90x20mm / Size 90x20mm  
Kapaklı Satılır / Complete with cover  
Kendinden Ara Bölmeli / Produced with self-separator Part



750 20

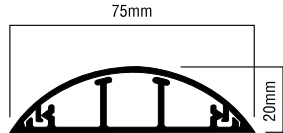

**75x20**

PVC Kanal / PVC Trunk  
Uzunluk 2m / Length 2m  
Ambalaj: 32m / Packaging: 32m  
Kesit 75x20mm / Size 75x20mm  
Kapaklı Satılır / With cover  
Kendinden Ara Bölmeli / Produced with self-separator Part  
Renk RAL 7023 Gri / Grey Color RAL 7023



750 21

**L Dirsek/L Corner**  
Ambalaj: 20 adet  
Packaging: 20Pieces



750 22

**T Dirsek/T Corner**  
Ambalaj: 20 adet  
Packaging: 20Pieces



750 23

**Sonlandırma  
End Cover**  
Ambalaj: 20 adet  
Packaging: 20Pieces



750 24

**Kanal Birleştirme Parçası  
Junction Piece**  
Ambalaj: 20 adet  
Packaging: 20Pieces



900 20

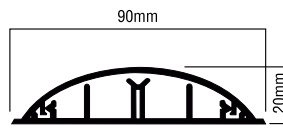

**90x20**

PVC Kanal / PVC Cable Trunking  
Uzunluk 2m / Length 2m  
Ambalaj: 24m / Packaging: 24m  
Kesit 90x20mm / Size 90x20mm  
Kapaklı Satılır / With cover  
Kendinden Ara Bölmeli / Produced with self-separator Part  
Renk RAL 7023 Gri / Grey Color RAL 7023



900 21

**L Dirsek/L Corner**  
Ambalaj: 20 adet  
Packaging: 20Pieces



900 22

**T Dirsek/T Corner**  
Ambalaj: 20 adet  
Packaging: 20Pieces



900 23

**Sonlandırma  
End Cover**  
Ambalaj: 20 adet  
Packaging: 20Pieces



900 24

**Kanal Birleştirme Parçası  
Junction Piece**  
Ambalaj: 20 adet  
Packaging: 20Pieces



Huş  
Birch



Meşe  
Oak



Ceviz  
Walnut

Kanalları istediğiniz renk seçeneklerinde boyanabilir.  
Can be painted with the color you choose

## KENDİNDEN YAPIŞKANLI DÖŞEMEÜSTÜ KABLO KANALLARI

## SELF ADHESIVE OVERFLOOR CABLE TRUNKS SYSTEMS



521 12



751 20



901 20



**D** LX LINE DELİKLİ PANO KANALLARI  
DLX LINE SLOTTED CABLE TRUNKINGS



**COMPASS** TRADING

*“Your COMPASS for Quality..”*



**DLX LINE DELİKLİ PANO KANALLARI**  
**DLX LINE SLOTTED CABLE TRUNKINGS**

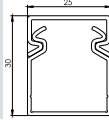

**257 30**

**25x30**

PVC Kablo Kanalı  
Kapaklı Satılır  
Ambalaj: 100m  
Renk: Gri RAL7030  
25x30 Slotted Cable Trunking  
Complete with cover  
Packaging: 100m  
Color: Grey RAL 7030

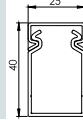

**257 40**

**25x40**

PVC Kablo Kanalı  
Kapaklı Satılır  
Ambalaj: 80m  
Renk: Gri RAL7030  
25x40 Slotted Cable Trunking  
Complete with cover  
Packaging: 80m  
Color: Grey RAL 7030

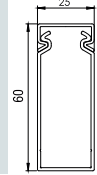

**257 60**

**25x60**

PVC Kablo Kanalı  
Kapaklı Satılır  
Ambalaj: 72m  
Renk: Gri RAL7030  
25x60 Slotted Cable Trunking  
Complete with cover  
Packaging: 72m  
Color: Grey RAL 7030

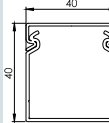

**407 40**

**40x40**

PVC Kablo Kanalı  
Kapaklı Satılır  
Ambalaj: 50m  
Renk: Gri RAL7030  
40x40 Slotted Cable Trunking  
Complete with cover  
Packaging: 50m  
Color: Grey RAL 7030

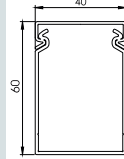

**407 60**

**40x60**

PVC Kablo Kanalı  
Kapaklı Satılır  
Ambalaj: 40m  
Renk: Gri RAL7030  
40x60 Slotted Cable Trunking  
Complete with cover  
Packaging: 40m  
Color: Grey RAL 7030

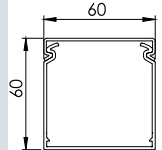

**607 60**

**60x60**

PVC Kablo Kanalı  
Kapaklı Satılır  
Ambalaj: 32m  
Renk: Gri RAL7030  
60x60 Slotted Cable Trunking  
Complete with cover  
Packaging: 32m  
Color: Grey RAL 7030

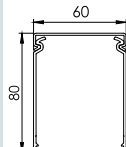

**807 60**

**80x60**

PVC Kablo Kanalı  
Kapaklı Satılır  
Ambalaj: 24m  
Renk: Gri RAL7030  
80x60 Slotted Cable Trunking  
Complete with cover  
Packaging: 24m  
Color: Grey RAL 7030

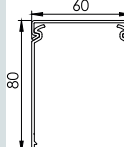

**607 80**

**60x80**

PVC Kablo Kanalı  
Kapaklı Satılır  
Ambalaj: 24m  
Renk: Gri RAL7030  
80x60 Slotted Cable Trunking  
Complete with cover  
Packaging: 24m  
Color: Grey RAL 7030

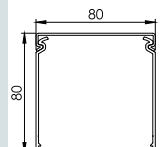

**807 80**

**80x80**

PVC Kablo Kanalı  
Kapaklı Satılır  
Ambalaj: 24m  
Renk: Gri RAL7030  
80x60 Slotted Cable Trunking  
Complete with cover  
Packaging: 24m  
Color: Grey RAL 7030

**DLX LINE DELİKLİ PANO KANALLARI**  
**DLX LINE SLOTTED CABLE TRUNKINGS**

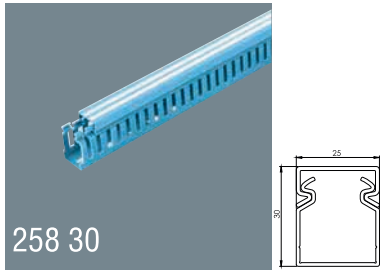

258 30

**25x30**

PVC Kablo Kanalı  
Kapaklı Satılır  
Ambalaj: 100m  
Renk: Mavi RAL5015  
25x30 Slotted Cable Trunking  
Complete with cover  
Packaging: 100m  
Color: Blue RAL5015

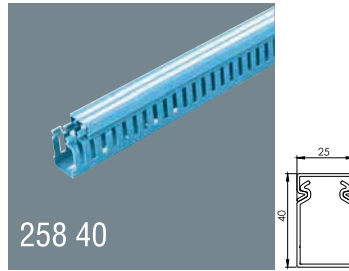

258 40

**25x40**

PVC Kablo Kanalı  
Kapaklı Satılır  
Ambalaj: 80m  
Renk: Mavi RAL5015  
25x40 Slotted Cable Trunking  
Complete with cover  
Packaging: 80m  
Color: Blue RAL5015

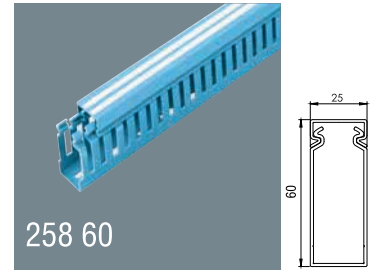

258 60

**25x60**

PVC Kablo Kanalı  
Kapaklı Satılır  
Ambalaj: 72m  
Renk: Mavi RAL5015  
25x40 Slotted Cable Trunking  
Complete with cover  
Packaging: 72m  
Color: Blue RAL5015

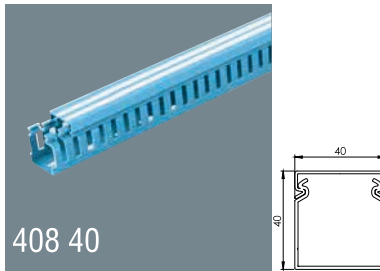

408 40

**40x40**

PVC Kablo Kanalı  
Kapaklı Satılır  
Ambalaj: 50m  
Renk: Mavi RAL5015  
40x40 Slotted Cable Trunking  
Complete with cover  
Packaging: 50m  
Color: Blue RAL5015

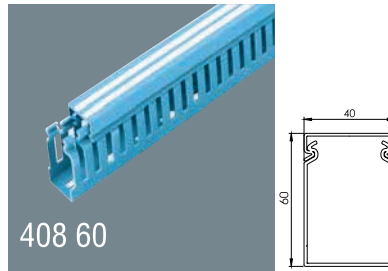

408 60

**40x60**

PVC Kablo Kanalı  
Kapaklı Satılır  
Ambalaj: 40m  
Renk: Mavi RAL5015  
40x60 Slotted Cable Trunking  
Complete with cover  
Packaging: 40m  
Color: Blue RAL5015

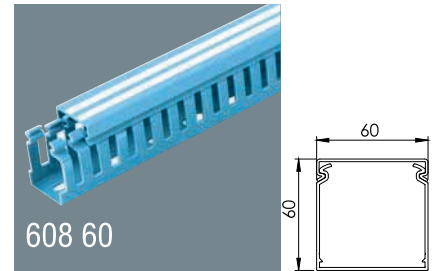

608 60

**60x60**

PVC Kablo Kanalı  
Kapaklı Satılır  
Ambalaj: 32m  
Renk: Mavi RAL5015  
60x60 Slotted Cable Trunking  
Complete with cover  
Packaging: 32m  
Color: Blue RAL5015

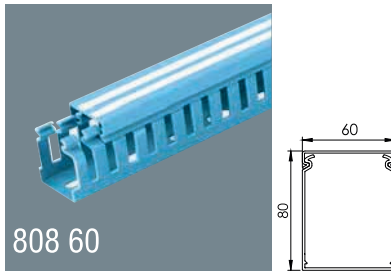

808 60

**80x60**

PVC Kablo Kanalı  
Kapaklı Satılır  
Ambalaj: 24m  
Renk: Mavi RAL5015  
80x60 Slotted Cable Trunking  
Complete with cover  
Packaging: 24m  
Color: Blue RAL5015

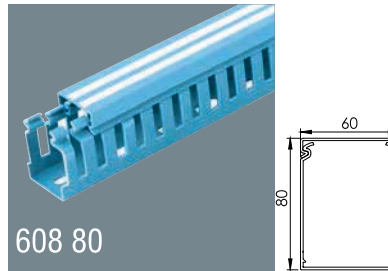

608 80

**60x80**

PVC Kablo Kanalı  
Kapaklı Satılır  
Ambalaj: 24m  
Renk: Mavi RAL5015  
80x60 Slotted Cable Trunking  
Complete with cover  
Packaging: 24m  
Color: Blue RAL5015

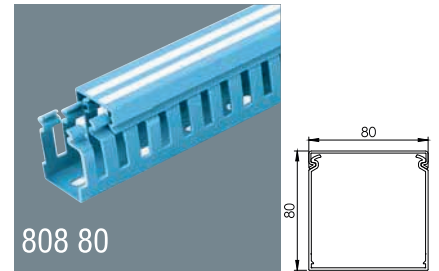

808 80

**80x80**

PVC Kablo Kanalı  
Kapaklı Satılır  
Ambalaj: 24m  
Renk: Mavi RAL5015  
80x60 Slotted Cable Trunking  
Complete with cover  
Packaging: 24m  
Color: Blue RAL5015

**DLX LINE DELİKLİ PANO KANALLARI**  
**DLX LINE SLOTTED CABLE TRUNKINGS**

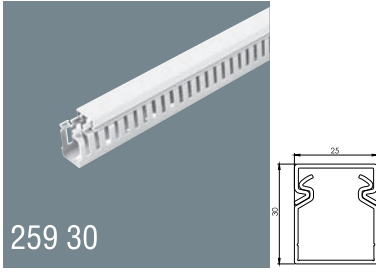

259 30

**25x30**

PVC Kablo Kanalı  
Kapaklı Satılır  
Ambalaj: 100m  
Renk: Beyaz RAL9016  
25x30 Slotted Cable Trunking  
Complete with cover  
Packaging: 100m  
Color: White RAL 9016

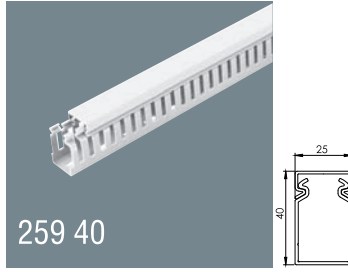

259 40

**25x40**

PVC Kablo Kanalı  
Kapaklı Satılır  
Ambalaj: 80m  
Renk: Beyaz RAL9016  
25x40 Slotted Cable Trunking  
Complete with cover  
Packaging: 80m  
Color: White RAL 9016

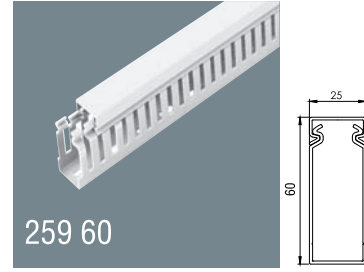

259 60

**25x60**

PVC Kablo Kanalı  
Kapaklı Satılır  
Ambalaj: 72m  
Renk: Beyaz RAL9016  
25x40 Slotted Cable Trunking  
Complete with cover  
Packaging: 72m  
Color: White RAL 9016

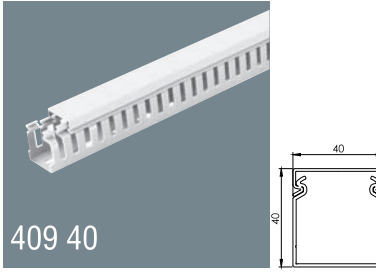

409 40

**40x40**

PVC Kablo Kanalı  
Kapaklı Satılır  
Ambalaj: 50m  
Renk: Beyaz RAL9016  
40x40 Slotted Cable Trunking  
Complete with cover  
Packaging: 50m  
Color: White RAL 9016

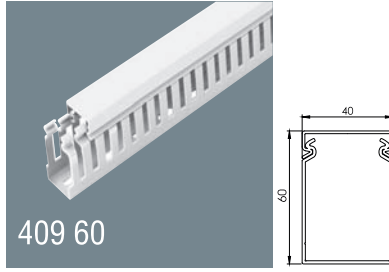

409 60

**40x60**

PVC Kablo Kanalı  
Kapaklı Satılır  
Ambalaj: 40m  
Renk: Beyaz RAL9016  
40x60 Slotted Cable Trunking  
Complete with cover  
Packaging: 40m  
Color: White RAL 9016

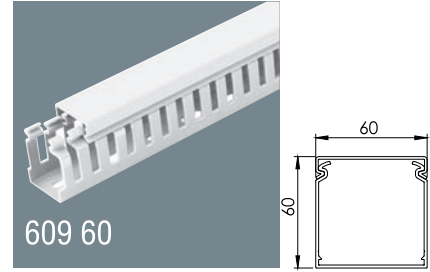

609 60

**60x60**

PVC Kablo Kanalı  
Kapaklı Satılır  
Ambalaj: 32m  
Renk: Beyaz RAL9016  
60x60 Slotted Cable Trunking  
Complete with cover  
Packaging: 32m  
Color: White RAL 9016

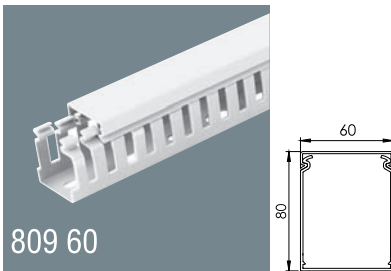

809 60

**80x60**

PVC Kablo Kanalı  
Kapaklı Satılır  
Ambalaj: 24m  
Renk: Beyaz RAL9016  
80x60 Slotted Cable Trunking  
Complete with cover  
Packaging: 24m  
Color: White RAL 9016

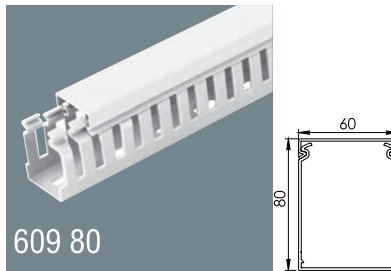

609 80

**60x80**

PVC Kablo Kanalı  
Kapaklı Satılır  
Ambalaj: 24m  
Renk: Beyaz RAL9016  
80x60 Slotted Cable Trunking  
Complete with cover  
Packaging: 24m  
Color: White RAL 9016

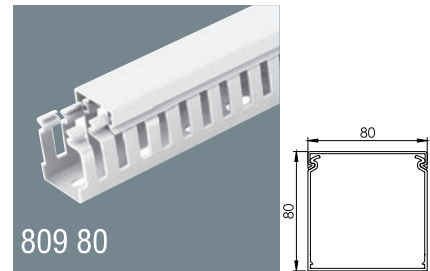

809 80

**80x80**

PVC Kablo Kanalı  
Kapaklı Satılır  
Ambalaj: 24m  
Renk: Beyaz RAL9016  
80x60 Slotted Cable Trunking  
Complete with cover  
Packaging: 24m  
Color: White RAL 9016



Tabanındaki delikler sayesinde hızlı ve kolay montaj sağlar.

Holes in the base allows quick and easy installation

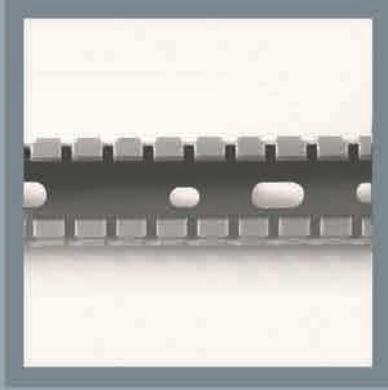

Kolay açılıp kapanma ile birlikte ekstra dayanıklılık sağlayan kapak ve gövde birleşimi.

The combination of the body and cover parts provide extra durability with its unique easy opening and design features.

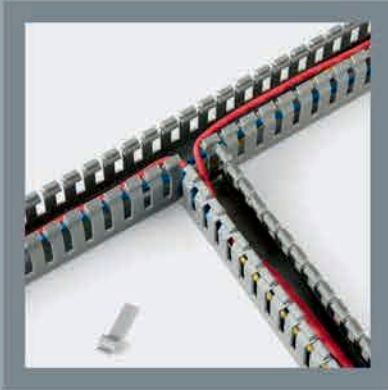

Tırnakları kırarak dilediğiniz yerden T bağlantılar yapabilirsiniz.

T connections can be made by breaking side nails.

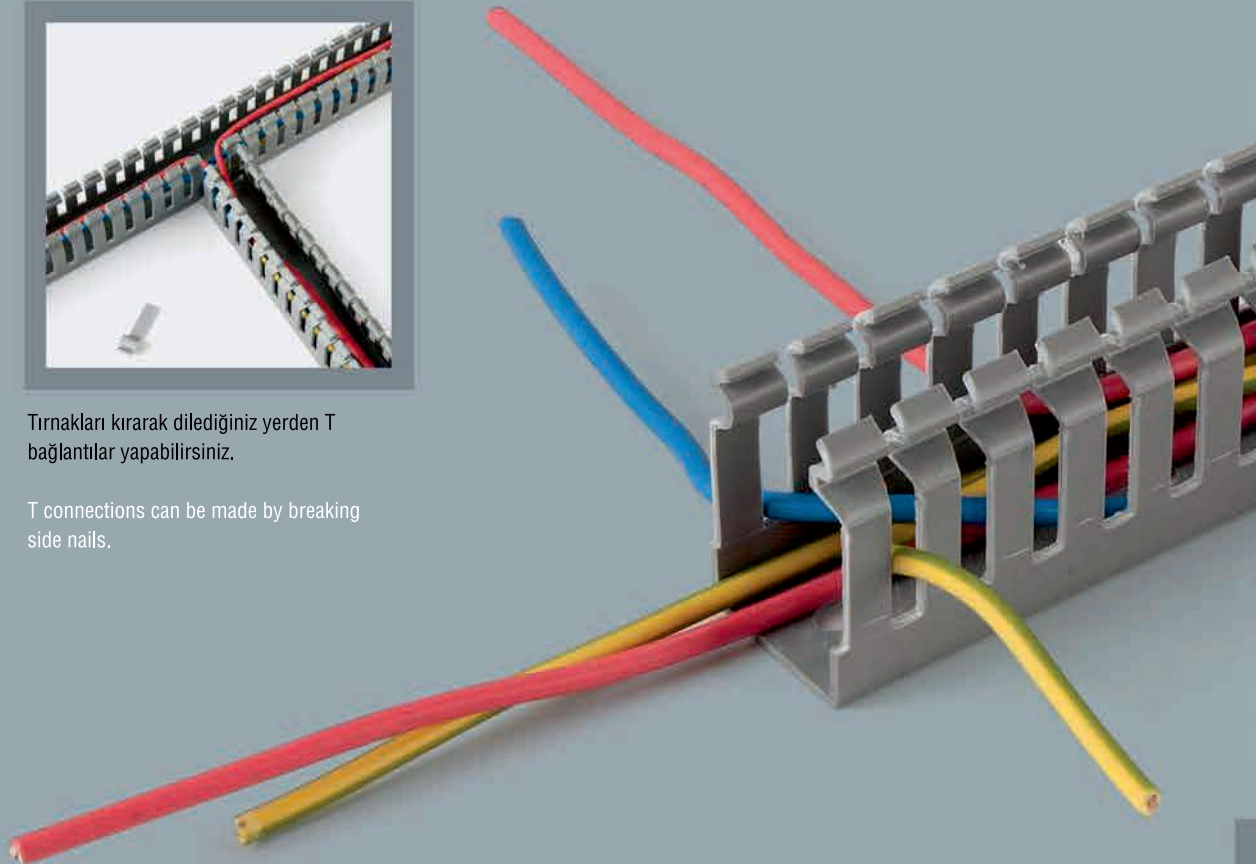

## T EKNIK ÖZELLİKLER TECHNICAL DETAILS

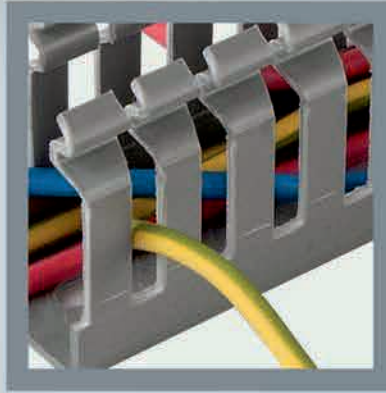
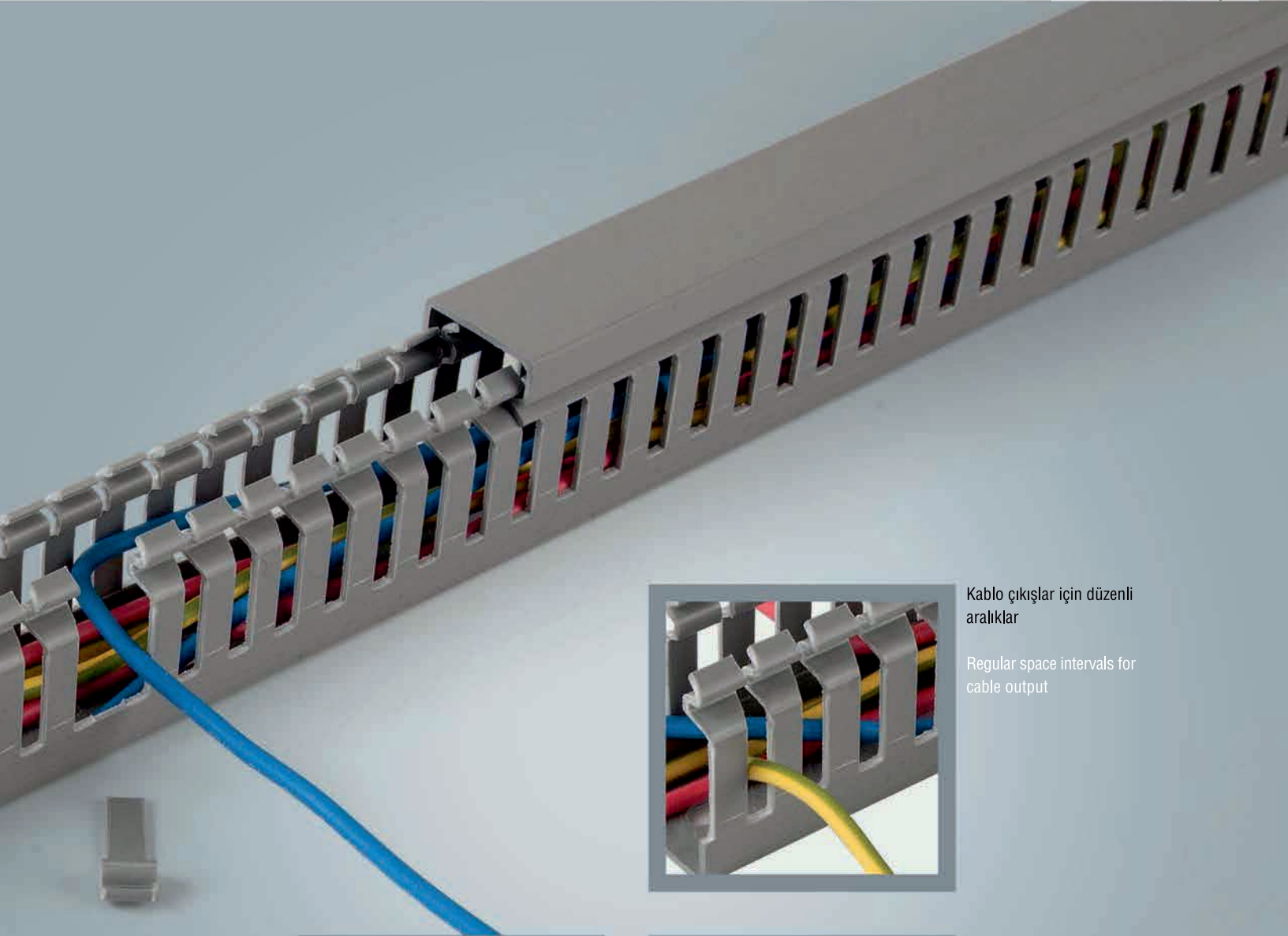

Kablo çıkışlar için düzenli aralıklar

Regular space intervals for cable output



Kesici aletlerle kolayca dilediğiniz ebatta kesebilirsiniz.

With Special Cutting tools, you can easily cut the trunking as your desired size.

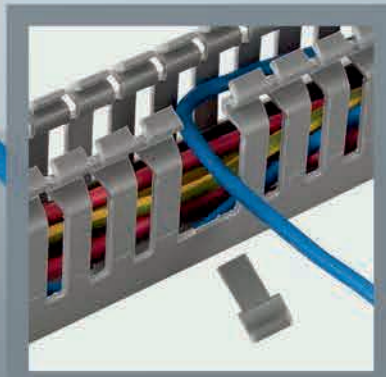

Önceden belirlenmiş kırılma hatları sayesinde dilediğiniz kadar kanal birleştirme ve kablo çıkışı yapabilirsiniz.

With its pre-designed breaking lines, it is comfortable to make a vast unit of cable joint and cable outputs.

DLX LINE DELİKLİ PANO KANAL KAPAĞI  
DLX LINE SLOTTED CABLE TRUNKINGS COVER



Ambalaj  
Package

<b>258 25</b>	25'lik Kapak/Cover	80m
<b>408 41</b>	40'lık Kapak/Cover	60m
<b>608 61</b>	60'lık Kapak/Cover	40m
<b>808 81</b>	80'lik Kapak/Cover	30m



Ambalaj  
Package

<b>259 27</b>	25'lik Kapak/Cover	80m
<b>408 43</b>	40'lık Kapak/Cover	60m
<b>608 62</b>	60'lık Kapak/Cover	40m
<b>808 83</b>	80'lik Kapak/Cover	30m

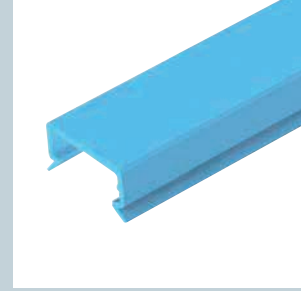

Ambalaj  
Package

<b>259 26</b>	25'lik Kapak/Cover	80m
<b>408 42</b>	40'lık Kapak/Cover	60m
<b>608 64</b>	60'lık Kapak/Cover	40m
<b>808 82</b>	80'lik Kapak/Cover	30m

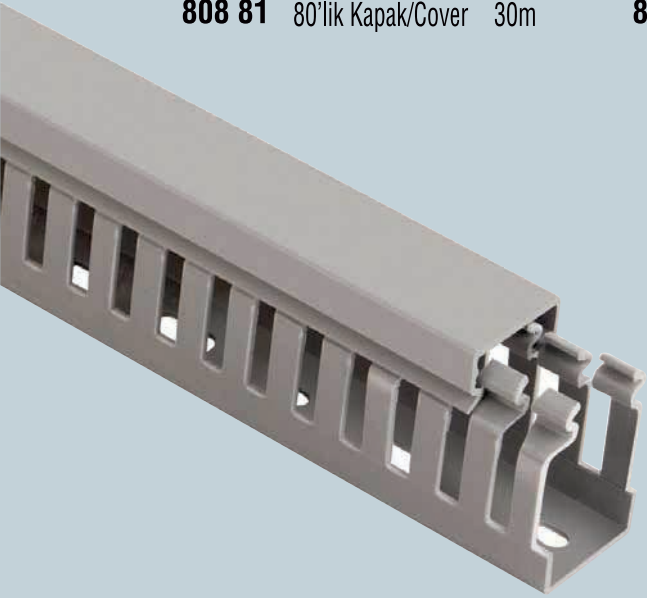

**Özellikler**

- Sert PVC UL94V0 M1 Alev Yayımayan
- Çalışma Ortam Sıcaklığı: -20° C +60° C
- Ral 7030 Gri

**Features**

- Rigid PVC UL94V0 M1 Self-extinguishing
- Temperature-Resistant: -20° C +60° C
- Ral 7030 Gri

Yükseklığı 30/40mm olan kanalların  
delik ölçüleri  
Overall Height 30/40mm

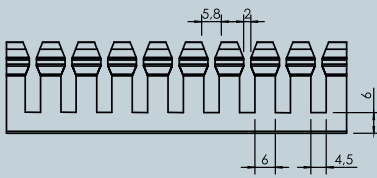

Yükseklığı 60mm olan kanalların  
delik ölçüleri  
Overall Height 60mm

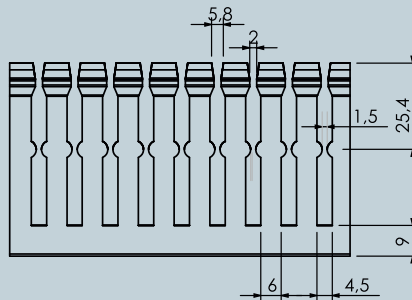

Yükseklığı 80mm olan kanalların  
delik ölçüleri  
Overall Height 80mm

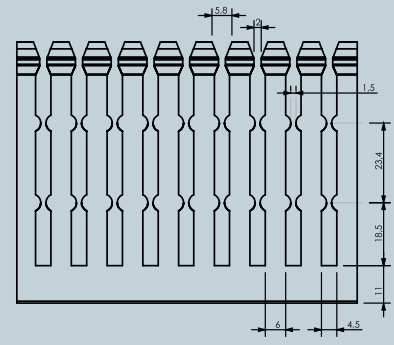

Taban genişliği 80mm olan kanalların delik ölçüleri

With 80mm

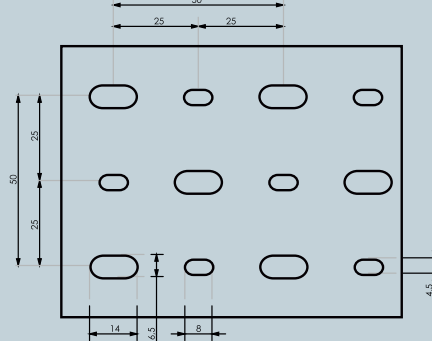

Taban genişliği 25/40/60cm olan kanalların  
delik ölçüleri

With 25/40/60mm

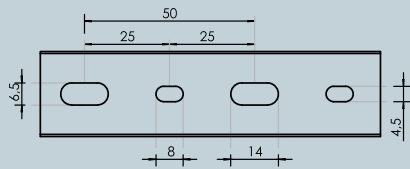



EBEKE, UPS, DATA & TELEFON PRİZLERİ  
UPS, ENERGY, DATA & TELEPHONE SOCKETS



**COMPASS** TRADING  
*"Your COMPASS for Quality.."*



## ŞEBEKE, UPS, DATA & TELEFON PRİZLERİ ENERGY, UPS, DATA & TELEPHONE SOCKETS



**245 45 45x45**  
45x45 Topraklı Priz (2 Modül)  
45x45 Grounded Socket (2 Module)  
Ambalaj: 20 Adet / Packaging: 20 pcs  
Renk RAL 9010-9016 Beyaz  
White Ral 9010-9016 Color  
Çocuk Korumalı / Built in Baby Protection  
45° Açılı Priz Yuvası / 45° Socket Hole



**245 46 45x45**  
45x45 Topraklı Priz (2 Modül)  
45x45 Grounded Socket (2 Module)  
Ambalaj: 20 adet / Packaging: 20 pcs  
Renk RAL 3020 Kırmızı  
Ral 3020 Red Color  
Çocuk Korumalı / Built in Baby Protection  
45° Açılı Priz Yuvası / 45° Socket Hole



**245 46-G 45x45**  
45x45 UPS Priz (2 Modül)  
45x45 UPS Socket (2 Module)  
Ambalaj: 20 Adet / Packaging: 20 pcs  
Renk RAL 9006 Yeşil  
Green Ral 9006 Color  
Çocuk Korumalı / Built in Baby Protection  
45° Açılı Priz Yuvası / 45° Socket Hole

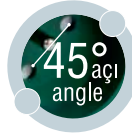

**245 47 Priz Birleştirme Barası**  
Socket junction Bar  
Ambalaj: 50 adet  
Packaging: 50 pcs

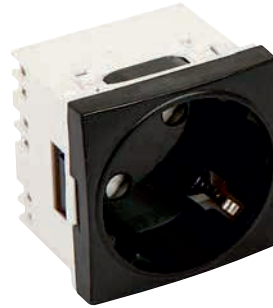

**245 45-B 45x45**  
45x45 Topraklı Priz (2 Modül)  
45x45 Grounded Socket (2 Module)  
Ambalaj: 20 adet / Packaging: 20 pcs  
Renk RAL 9005 Siyah  
Ral 9005 Black Color  
Çocuk Korumalı / Built in Baby Protection  
45° Açılı Priz Yuvası / 45° Socket Hole



## TEKNİK ÖZELLİKLER / TECHNICAL SPECIFICATIONS

45x45mm formatındadır.

Kolay kablo bağlantı baralarına sahiptir.

Kontakt girişleri 2.5 mm<sup>2</sup> kesitindeki kabloları uygundur.

(Tek damar ve çok telli kablo giriş yerine uygundur.)

Şebeke prizi renk RAL 9010 Beyaz'dır.

UPS Priz renk RAL 3020 kırmızıdır.

Köprü bağlantısına ihtiyaç yoktur.

Hızlı montaj imkanına sahiptir.

Çocuk korumalıdır.

45° açılı fiş yuvasına sahiptir.

45x45mm dimensions.

Practical and easy cable connection systems.

Contact entrance is available for cable cross section of 2.5 mm<sup>2</sup>.

(Suitable for entrance of solid wire and stranded wire.)

Grounded Socket Ral 9010 White.

UPS Socket White Ral 3020 Red

No need for bridge connection

Quick installation.

Built in Baby Protection

45° angled plug slot.





DLX SİSTEM KABLO KANALLARI İÇİN 2-4-6-8 MODÜL ÇOKLU PRİZLER  
2-4-6-8 MODULES OF SOCKETS/MULTIPLE SOCKETS FOR CABLE TRUNKING



245 46  
TEKLİ UPS PRİZ  
SINGLE UPS SOCKET



245 45  
TEKLİ ŞEBEKE PRİZ  
SINGLE GROUNDED SOCKET



245 86  
2'Lİ UPS PRİZ  
DOUBLE UPS SOCKET



245 85  
2'Lİ ŞEBEKE PRİZ  
DOUBLE GROUNDED SOCKET



245 88  
3'LÜ UPS PRİZ  
TRIPLE UPS SOCKET



245 87  
3'LÜ ŞEBEKE PRİZ  
TRIPLE GROUNDED SOCKET









245 90  
4'LÜ UPS PRİZ  
QUADRUPLE UPS SOCKET



245 89  
4'LÜ ŞEBEKE PRİZ  
QUADRUPLE GROUNDED SOCKET



DLX SİSTEM KABLO KANALLARI İÇİN 2-4-6-8 MODÜL ÇOKLU PRİZLER  
2-4-6-8 MODULES OF SOCKETS/MULTIPLE SOCKETS FOR CABLE TRUNKING

AÇIKLAMA Description	Ref	RENK Colour	MODÜL Module	AMBALAJ Packaging
 <b>16 A 250 V AC 2P+T</b>	245 45	BEYAZ WHITE	2	20
 <b>16 A 250 V AC 2 X 2P+T</b>	245 85	BEYAZ WHITE	4	10
 <b>16 A 250 V AC 3 X 2P+T</b>	245 87	BEYAZ WHITE	6	16
 <b>16 A 250 V AC 4 X 2P+T</b>	245 89	BEYAZ WHITE	8	12
 <b>16 A 250 V AC 2P+T</b>	245 46	KIRMIZI RED	2	20
 <b>16 A 250 V AC 2 X 2P+T</b>	245 86	KIRMIZI RED	4	10
 <b>16 A 250 V AC 3 X 2P+T</b>	245 88	KIRMIZI RED	6	16
 <b>16 A 250 V AC 4 X 2P+T</b>	245 90	KIRMIZI RED	8	12

ŞEBEKE, UPS, DATA & TELEFON PRİZLERİ  
ENERGY, UPS, DATA & TELEPHONE SOCKETS



245 87

**45x45**  
Data Telefon Priz Kapağı Eko  
(2 Modül)  
Ambalaj: 1 adet / Packaging: 1 pcs  
Keystone Jack For Data-Telephone  
(2 Module)  
Toz Korumalı / Dust Protected



245 88

**45x22.5**  
Data Telefon Priz Kapağı Eko  
(1 Modül)  
Ambalaj: 1 adet / Packaging: 1 pcs  
Keystone Jack For Data-Telephone  
(1 Module)  
Toz Korumalı / Dust Protected



245 86

**45x45**  
Data Telefon Priz Kapağı Etiketli  
(2 Modül)  
Ambalaj: 1 adet / Packaging: 1 pcs  
Keystone Jack For Data-Telephone  
With label (2 Module)  
Toz Korumalı / Dust Protected



245 89

**Fiber Kaset**  
Ambalaj: 1 adet / Packaging: 1 pcs



245 01

**2 Portlu USB Şarj**  
Ambalaj: 1 adet / Packaging: 1 pcs

**ŞEBEKE, UPS, DATA & TELEFON PRİZLERİ**  
**ENERGY, UPS, DATA & TELEPHONE SOCKETS**



245 49

**45x45**  
Data Telefon Priz Kapağı  
(2 Modül)  
Ambalaj: 1 adet / Packaging: 1 pcs  
Keystone Jack For Data-Telephone  
(2 Module)  
Toz Korunmalı / Dust Protected



245 50

**45x22.5**  
Data Telefon Priz Kapağı  
(1 Modül)  
Ambalaj: 1 adet / Packaging: 1 pcs  
Keystone Jack For Data-Telephone  
(1 Module)  
Toz Korunmalı / Dust Protected



245 51

**45x22.5**  
Boşluk Kapama (1 Modül)  
Blind cover (1 Module)  
Ambalaj: 1 adet / Packaging: 1 pcs



245 48

**45x45**  
Boşluk Kapama (2 Modül)  
Blind cover (2 Module)  
Ambalaj: 1 adet / Packaging: 1 pcs



245 44

**45x45 İngiliz Tipi Priz**  
45x45 British Type Socket  
Ambalaj: 1 adet  
Packaging: 1 pcs



245 57

**45x45 WGA Priz Konnektörü**  
45x45 WGA Socket Connector  
Ambalaj: 1 adet / Packaging: 1 pcs



245 66

**45x22.5 Anahtar**  
45x22.5 Switch  
Ambalaj: 1 adet / Packaging: 1 pcs



245 62

**45x22.5 USB**  
45x22.5 USB  
Ambalaj: 1 adet / Packaging: 1 pcs



245 52

**CAT 3 Telefon Konnektörü**  
CAT 3 Keystone Jack For Telephone  
Ambalaj: 1 adet / Packaging: 1 pcs  
RJ 11-12 (1 Modül) / RJ 11-12 (2 Module)



245 53

**CAT 5 Data Konnektörü**  
CAT 5 Keystone Jack For Data  
Ambalaj: 1 adet / Packaging: 1 pcs  
RJ 45 (1 Modül) / RJ 45 (2 Module)



245 54

**CAT 6 Data Konnektörü**  
CAT 6 Keystone Jack For Data  
Ambalaj: 1 adet / Packaging: 1 pcs  
RJ 45 (1 Modül) / RJ 45 (2 Module)



245 63

**45x22.5 HDMI**  
45x22.5 HDMI  
Ambalaj: 1 adet / Packaging: 1 pcs



245 67

**CAT 3 Plug**  
CAT 3 Plug  
Ambalaj: 100 adet  
Packaging: 100 pcs



245 69

**CAT6 Plug**  
CAT 6 Plug  
Ambalaj: 100 adet  
Packaging: 100 pcs



245 56

**45x45 F Tipi Tv Prizi**  
45x45 F-type TV socket  
Ambalaj: 1 adet / Packaging: 1 pcs



245 91

**45x22.5 Ses & Video**  
45x22.5 Audio & Video  
Ambalaj: 1 adet  
Packaging: 1 pcs

### KABLO BAĞLARI / CABLE TIES



Ürün Kodu Product Code	Boyutlar / Dimensions		Renk Colour	Azami Sıkma Çapı (mm) Maximum coupling diameter (mm)	Açılma Mukavemeti Expansion Resistance	Poşet Miktarı Packaging Units
	Uzunluk x En (mm) Length x Width (mm)					
TSL - 100 M TSL - 140 M TSL - 200 M	100 150 200	2,5	Beyaz / Siyah Beyaz / Siyah Beyaz / Siyah	25 38 50	8 kg	100 ad./pcs
TSL - 150 I TSL - 200 I TSL - 250 I TSL - 300 I TSL - 370 I	150 200 250 300 370	3,6	Beyaz / Siyah Beyaz / Siyah Beyaz / Siyah Beyaz / Siyah Beyaz / Siyah	38 57 69 87 110	18 kg	
TSL - 200 ST TSL - 250 ST TSL - 300 ST TSL - 380 ST TSL - 400 ST	200 250 300 380 400	4,8	Beyaz / Siyah Beyaz / Siyah Beyaz / Siyah Beyaz / Siyah Beyaz / Siyah	56 72 87 109 129	22 kg	
TSL - 300 LHD TSL - 380 LHD TSL - 550 LHD	300 380 550	7,6	Beyaz / Siyah Beyaz / Siyah Beyaz / Siyah	82 108 162	54 kg	
TSL - 750 LHD	750	9,0	Beyaz / Siyah	233	79 kg	

### YAPIŞKAN KROŞELER / ADHESIVE CROSHETS



Ürün Kodu Product Code	Boyutlar / Dimensions		Renk Colour	Kablo Bağı Girişi (mm) Cable Tie Entrance	Taşıma Mukavemeti Carriage Resistance	Poşet Miktarı Packaging Units
	Uzunluk x En (mm) Length x Width (mm)					
SDM - 101 SDM - 102	19 28	19 28	Beyaz / Siyah Beyaz / Siyah	4 4,5	8 kg 15 kg	100 ad.







**D**ÖŞEME ALTI ÇIKIŞ GÜÇ DAĞITIM KUTULARI  
UNDERFLOOR POWER DISTRIBUTION BOXES

  
**COMPASS** TRADING  
"Your COMPASS for Quality.."

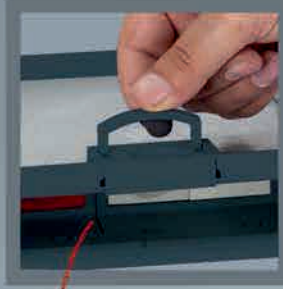

Açıp kapamayı kolaylaştıran tutma ünitesi

Holding unit makes easy opening & closing



Üzerine ağırlık binmesi halinde kablolarda hasar oluşmasını önleyecek kauçuk kapatici.

Specially designed rubber part that protects any damage comes from weight factor



Gövde ve kapak bağlantısındaki dayanıklılığı artıran metal pim.

Extra durability with its distinctively made steel pin that helps the endurance between body and cover parts



Döşemeyle arasındaki seviye farkını ayarlama aparatları.

Adjustment apparatus to balance the level difference on the floor



Kapakta çift taraflı monte etme imkanı

Two sided possibility to mount cover part

Tırnak geçmeli sistemi ile kolay montaj edilebilen priz çekirdeği yuvaları  
Easy installation with plug-in system nail connection system

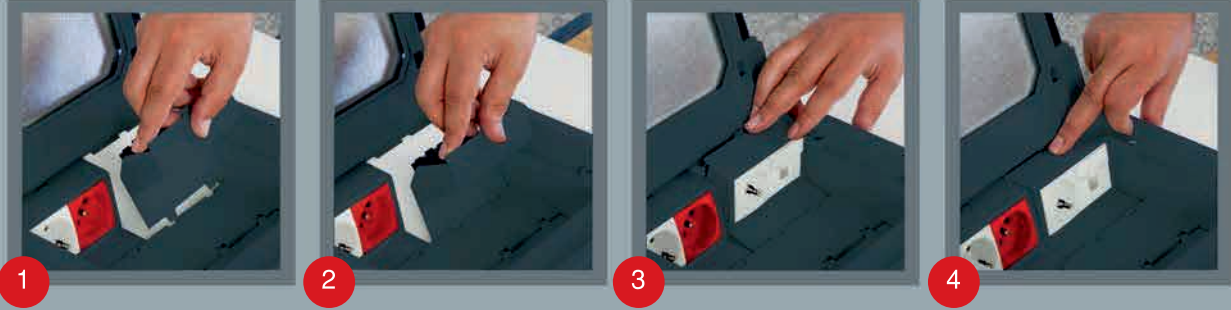

### BOYUTLAR / DIMENSIONS

İÇ KASA / INNER BOX

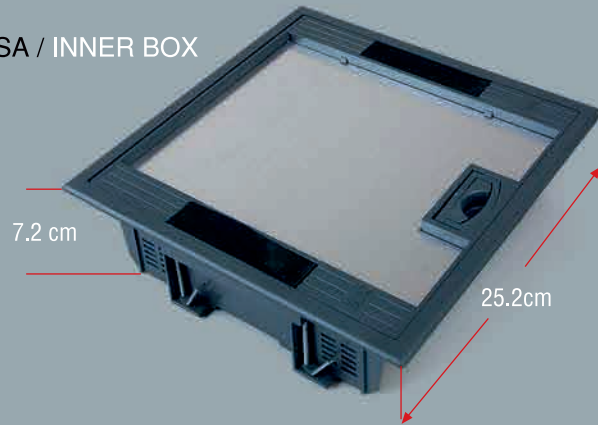

DIŞ KASA / OUTER BOX

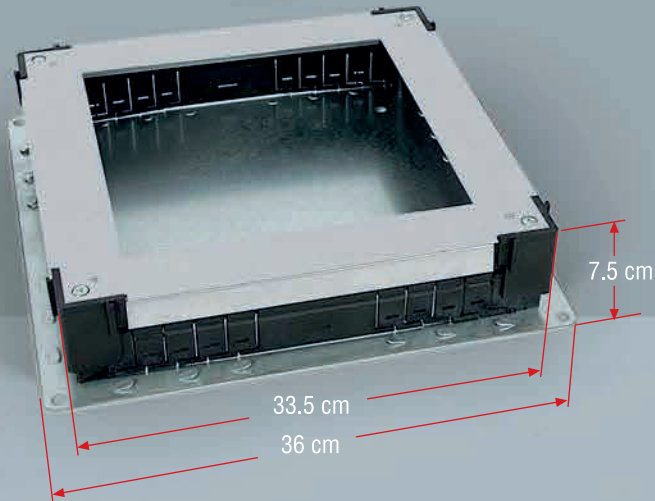



DÖŞEME ALTI ÇIKIŞ GÜÇ DAĞITIM KUTULARI  
UNDERFLOOR POWER DISTRIBUTION BOXES



**890 08** Döşeme Altı Çıkış Kutusu  
16 Modül 45x22.5mm  
Underfloor Outlet Box 16 Module  
Ambalaj: 1 adet / Packaging: 1 pcs  
4 Kaide / 4 Frame  
Gövde ölçüsü: 23,5x23,5 cm  
Body size: 23,5x23,5 cm  
\* Boş Satılır / Sales without modules



**890 09** Şap Altı Buat Kasası  
Underfloor Box Metallic Base  
Asansörlü / Lift system  
Dış ölçü: 36x36 cm Outer size: 36x36 cm  
Ambalaj: 1 adet / Packaging: 1 pcs



**890 11**  
Şap Altı Buat Kasası  
Underfloor Box Plastic base  
Ambalaj: 1 adet / Packaging: 1 pcs



**890 10** Döşeme Altı Çıkış Kutusu  
Buat Kasası (Takım) 16 Modül  
Underfloor Output Box  
Junction Box (Pair) 16 Modüle  
Çıkış Kutusu / 16 Module  
Ambalaj: 1 adet / Packaging: 1 pcs  
4 Kaide / 4 Base  
Dış ölçüsü: 36x36 cm  
Outer size: 36x36 cm  
\* Boş Satılır / Sales without modules

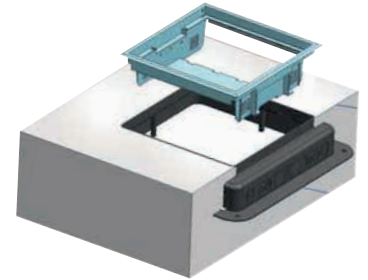

**890 13** Şap Altı Buat Kasası Kapağı  
Underfloor Box Metallic Base Cover  
Dış ölçü: 23,5x23,5 cm Outer size: 23,5x23,5 cm  
Ambalaj: 1 adet / Packaging: 1 pcs





**D**AHİLİ 45x45 MODÜL PRİZ KUTULARI / YAPISAL KABLOLAMA SİSTEMLERİ  
45x45 SOCKET BOXES / STRUCTURAL CABLING SYSTEMS

## DAHİLİ 45x45 MODÜL PRİZ KUTULARI 45x45 SOCKET BOXES



880 08

### 8'li Modül Priz Kutusu 45x45mm

Socket Box for 8 Module 45x45mm

Ölçüsü: 210x110x70mm Size: 210x110x70mm

Ambalaj: 1 adet / Packaging: 1 pcs



880 09

### Dağıtım Buatı

Distribution Box

Ölçüsü / Size: 210x110x70mm

Ambalaj: 1 adet / Packaging: 1 pcs

## YAPISAL KABLOLAMA SİSTEMLERİ STRUCTURAL CABLING SYSTEMS

### PATCH PANEL



245 70	1 Adet / Pcs	CAT5 e UTP Patch Panel 24 Port
245 71	1 Adet / Pcs	CAT5 e UTP Patch Panel 48 Port
245 72	1 Adet / Pcs	CAT6 e UTP Patch Panel 24 Port
245 73	1 Adet / Pcs	CAT6 e UTP Patch Panel 48 Port

### PATCH CORD



245 80	1 Adet / Pcs	CAT5 e UTP 24 AWG Patch Cord 1m
245 81	1 Adet / Pcs	CAT5 e UTP 24 AWG Patch Cord 3m
245 82	1 Adet / Pcs	CAT5 e UTP 24 AWG Patch Cord 5m
245 83	1 Adet / Pcs	CAT6 e UTP 24 AWG Patch Cord 1m
245 84	1 Adet / Pcs	CAT6 e UTP 24 AWG Patch Cord 3m

### KABLO OMURGASI



245 85	1 Adet / Pcs	Kablo Omurgası Cable Spine
--------	-----------------	-------------------------------



Bu ürün grubu ile ilgili özel uygulama siparişleri alınır.  
*Custom made application orders are welcome in this product group.*



**O** FİS BLOK SİSTEMLERİ  
BLOCK OFFICE SYSTEMS

OFİS BLOK SİSTEMLERİ  
BLOCK OFFICE SYSTEMS



<b>980 01</b>	1 Adet / Pcs	4 UPS + 3 ŞBK + 2 TLF + 2 DATA	(594x65x52 mm)
<b>980 02</b>	1 Adet / Pcs	4 UPS + 3 ŞBK + 2 TLF + 1 DATA	(572x65x52 mm)
<b>980 03</b>	1 Adet / Pcs	4 UPS + 3 ŞBK + 1 TLF + 1 DATA	(549x65x52 mm)
<b>980 04</b>	1 Adet / Pcs	4 UPS + 2 ŞBK + 2 TLF + 2 DATA	(549x65x52 mm)
<b>980 05</b>	1 Adet / Pcs	4 UPS + 2 ŞBK + 2 TLF + 1 DATA	(527x65x52 mm)
<b>980 06</b>	1 Adet / Pcs	4 UPS + 2 ŞBK + 1 TLF + 1 DATA	(504x65x52 mm)
<b>980 07</b>	1 Adet / Pcs	4 UPS + 1 ŞBK + 2 TLF + 2 DATA	(504x65x52 mm)
<b>980 08</b>	1 Adet / Pcs	4 UPS + 1 ŞBK + 2 TLF + 1 DATA	(482x65x52 mm)
<b>980 09</b>	1 Adet / Pcs	4 UPS + 1 ŞBK + 1 TLF + 1 DATA	(459x65x52 mm)
<b>980 10</b>	1 Adet / Pcs	3 UPS + 3 ŞBK + 2 TLF + 2 DATA	(549x65x52 mm)
<b>980 11</b>	1 Adet / Pcs	3 UPS + 3 ŞBK + 2 TLF + 1 DATA	(527x65x52 mm)
<b>980 12</b>	1 Adet / Pcs	3 UPS + 3 ŞBK + 1 TLF + 1 DATA	(504x65x52 mm)
<b>980 13</b>	1 Adet / Pcs	3 UPS + 2 ŞBK + 2 TLF + 2 DATA	(504x65x52 mm)
<b>980 14</b>	1 Adet / Pcs	3 UPS + 2 ŞBK + 2 TLF + 1 DATA	(482x65x52 mm)
<b>980 15</b>	1 Adet / Pcs	3 UPS + 2 ŞBK + 1 TLF + 1 DATA	(459x65x52 mm)
<b>980 16</b>	1 Adet / Pcs	3 UPS + 1 ŞBK + 2 TLF + 2 DATA	(459x65x52 mm)
<b>980 17</b>	1 Adet / Pcs	3 UPS + 1 ŞBK + 2 TLF + 1 DATA	(437x65x52 mm)
<b>980 18</b>	1 Adet / Pcs	3 UPS + 1 ŞBK + 1 TLF + 1 DATA	(414x65x52 mm)
<b>980 19</b>	1 Adet / Pcs	2 UPS + 2 ŞBK + 2 TLF + 2 DATA	(459x65x52 mm)
<b>980 20</b>	1 Adet / Pcs	2 UPS + 2 ŞBK + 2 TLF + 1 DATA	(437x65x52 mm)
<b>980 21</b>	1 Adet / Pcs	2 UPS + 2 ŞBK + 1 TLF + 1 DATA	(414x65x52 mm)
<b>980 22</b>	1 Adet / Pcs	2 UPS + 1 ŞBK + 2 TLF + 2 DATA	(414x65x52 mm)
<b>980 23</b>	1 Adet / Pcs	2 UPS + 1 ŞBK + 2 TLF + 1 DATA	(392x65x52 mm)
<b>980 24</b>	1 Adet / Pcs	2 UPS + 1 ŞBK + 1 TLF + 1 DATA	(369x65x52 mm)
<b>980 25</b>	1 Adet / Pcs	2 UPS + 1 ŞBK + 1 TLF	(347x65x52 mm)
<b>980 26</b>	1 Adet / Pcs	1 UPS + 1 ŞBK + 1 TLF + 1 DATA	(324x65x52 mm)
<b>980 27</b>	1 Adet / Pcs	1 UPS + 1 ŞBK + 1 TLF	(302x65x52 mm)
<b>980 28</b>	1 Adet / Pcs	4 UPS + 3 ŞBK	(504x65x52 mm)
<b>980 29</b>	1 Adet / Pcs	4 UPS + 2 ŞBK	(459x65x52 mm)
<b>980 30</b>	1 Adet / Pcs	4 UPS + 1 ŞBK	(414x65x52 mm)
<b>980 31</b>	1 Adet / Pcs	3 UPS + 3 ŞBK	(459x65x52 mm)
<b>980 32</b>	1 Adet / Pcs	3 UPS + 2 ŞBK	(414x65x52 mm)
<b>980 33</b>	1 Adet / Pcs	3 UPS + 1 ŞBK	(369x65x52 mm)
<b>980 34</b>	1 Adet / Pcs	2 UPS + 2 ŞBK	(369x65x52 mm)
<b>980 35</b>	1 Adet / Pcs	2 UPS + 1 ŞBK	(324x65x52 mm)
<b>980 36</b>	1 Adet / Pcs	1 UPS + 1 ŞBK	(279x65x52 mm)

\* ŞBK= Grounded Socket (245 45)



## OFİS BLOK SİSTEMLERİ BLOCK OFFICE SYSTEMS



980 37	1 Adet / Pcs	10 UPS (639x65x52 mm)
980 38	1 Adet / Pcs	9 UPS (594x65x52 mm)
980 39	1 Adet / Pcs	8 UPS (549x65x52 mm)
980 40	1 Adet / Pcs	7 UPS (504x65x52 mm)
980 41	1 Adet / Pcs	6 UPS (459x65x52 mm)
980 42	1 Adet / Pcs	5 UPS (414x65x52 mm)
980 43	1 Adet / Pcs	4 UPS (369x65x52 mm)
980 44	1 Adet / Pcs	3 UPS (324x65x52 mm)
980 45	1 Adet / Pcs	2 UPS (279x65x52 mm)



980 46	1 Adet / Pcs	10 ŞBK (639x65x52 mm)
980 47	1 Adet / Pcs	9 ŞBK (594x65x52 mm)
980 48	1 Adet / Pcs	8 ŞBK (549x65x52 mm)
980 49	1 Adet / Pcs	7 ŞBK (504x65x52 mm)
980 50	1 Adet / Pcs	6 ŞBK (459x65x52 mm)
980 51	1 Adet / Pcs	5 ŞBK (414x65x52 mm)
980 52	1 Adet / Pcs	4 ŞBK (369x65x52 mm)
980 53	1 Adet / Pcs	3 ŞBK (324x65x52 mm)
980 54	1 Adet / Pcs	2 ŞBK (279x65x52 mm)



980 55	1 Adet / Pcs	4 Modül Boş Blok 2 Yan Kapak (279x65x52 mm) 4 Module Empty With 2 Side Covers (279x65x52 mm)
980 56	1 Adet / Pcs	6 Modül Boş Blok 2 Yan Kapak (324x65x52 mm) 6 Module Empty With 2 Side Covers (324x65x52 mm)
980 57	1 Adet / Pcs	8 Modül Boş Blok 2 Yan Kapak (369x65x52 mm) 8 Module Empty With 2 Side Covers (369x65x52 mm)
980 58	1 Adet / Pcs	10 Modül Boş Blok 2 Yan Kapak (414x65x52 mm) 10 Module Empty With 2 Side Covers (414x65x52 mm)
980 59	1 Adet / Pcs	12 Modül Boş Blok 2 Yan Kapak (459x65x52 mm) 12 Module Empty With 2 Side Covers (459x65x52 mm)
980 60	1 Adet / Pcs	14 Modül Boş Blok 2 Yan Kapak (504x65x52 mm) 14 Module Empty With 2 Side Covers (504x65x52 mm)
980 61	1 Adet / Pcs	16 Modül Boş Blok 2 Yan Kapak (549x65x52 mm) 16 Module Empty With 2 Side Covers (549x65x52 mm)
980 62	1 Adet / Pcs	18 Modül Boş Blok 2 Yan Kapak (594x65x52 mm) 18 Module Empty With 2 Side Covers (594x65x52 mm)
980 63	1 Adet / Pcs	20 Modül Boş Blok 2 Yan Kapak (639x65x52 mm) 20 Module Empty With 2 Side Covers (639x65x52 mm)

\* ŞBK= Grounded Socket (245 45)

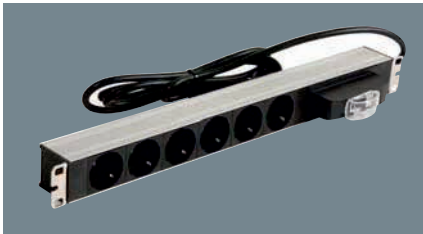

980 65

Kabin Tipi Sigortalı Priz Bloğu (6 ŞBK 1U)  
Rack Cabinet Type 1U Power Socket Group  
With Circuit Breaker (6 sockets with fuse)  
Ambalaj: 1 adet / Packaging: 1 pcs



980 68

Kabin Tipi Anahtarlı Priz Bloğu (6 ŞBK 1U)  
Rack Cabinet Type 1U Power Socket Group  
With Switch (6 sockets with fuse)  
Ambalaj: 1 adet / Packaging: 1 pcs



980 69

Kabin Tipi Şok Korumalı Priz Bloğu (6 ŞBK 1U)  
Rack Cabinet Type 1U Power Socket Group  
With Parafudr (6 sockets with fuse)  
Ambalaj: 1 adet / Packaging: 1 pcs

## DİKEY PRİZ BLOKLARI VERTICAL ALLUMINIUM FLOOR STANDING POWER SOCKET



**980 64** Dikey Tekyüz Priz Bloğu  
One Face Vertical Alluminium Floor  
Ambalaj: 1 adet / Packaging: 1 pcs



**980 66** Dikey Çift yüz Priz Bloğu  
Double Face Vertical Alluminium Floor  
Ambalaj: 1 adet / Packaging: 1 pcs



**980 67** Dikey Dört yüz Priz Bloğu  
Four Face Vertical Alluminium Floor  
Ambalaj: 1 adet / Packaging: 1 pcs

Boş Satılır.  
Priz kombinasyonları için  
fiyat sorunuz.

Sales (without sockets) as empty  
Ask for pricing with different  
socket combinations.



**M**ASA ÜSTÜ PRİZ SİSTEMLERİ  
DEKSTOP SOCKET SYSTEMS



MASA OFİS BLOK SİSTEMLERİ / DEKSTOP SOCKET SYSTEMS



CODE	MODULE	RENK/COLOR	Adet/Unit
9810501	5	Anodized	5
9810502		Siyah/Black	
9810503		Beyaz/White	
9810801	8	Anodized	8
9810802		Siyah/Black	
9810803		Beyaz/White	
9811201	12	Anodized	12
9811202		Siyah/Black	
9811203		Beyaz/White	
9811601	16	Anodized	16
9811602		Siyah/Black	
9811603		Beyaz/White	
9812001	20	Anodized	20
9812002		Siyah/Black	
9812003		Beyaz/White	



CODE	MODULE	RENK/COLOR	Adet/Unit
9840501	5	Anodized	5
9840502		Siyah/Black	
9840503		Beyaz/White	
9840801	8	Anodized	8
9840802		Siyah/Black	
9840803		Beyaz/White	
9841201	12	Anodized	12
9841202		Siyah/Black	
9841203		Beyaz/White	
9841601	16	Anodized	16
9841602		Siyah/Black	
9841603		Beyaz/White	
9842001	20	Anodized	20
9842002		Siyah/Black	
9842003		Beyaz/White	





## MASA OFİS BLOK SİSTEMLERİ / DEKSTOP SOCKET SYSTEMS



CODE	MODULE	RENK/COLOR	Adet/Unit
9990601	6	Inox	1
9990602		Siyah/Black	
9990603		Bronz/Broze	
9990604		Altın/Gold	
9990801	8	Inox	1
9990802		Siyah/Black	
9990803		Bronz/Broze	
9990804		Altın/Gold	
9991001	10	Inox	1
9991002		Siyah/Black	
9991003		Bronz/Broze	
9991004		Altın/Gold	



CODE	MODULE	RENK/COLOR	Adet/Unit
9850501	5	Anodized	5
9850502		Siyah/Black	
9850503		Beyaz/White	
9850801	8	Anodized	8
9850802		Siyah/Black	
9850803		Beyaz/White	
9851201	12	Anodized	12
9851202		Siyah/Black	
9851203		Beyaz/White	
9851601	16	Anodized	16
9851602		Siyah/Black	
9851603		Beyaz/White	
9852001	20	Anodized	20
9852002		Siyah/Black	
9852003		Beyaz/White	





**COMPASS** TRADING  
*"Your COMPASS for Quality.."*



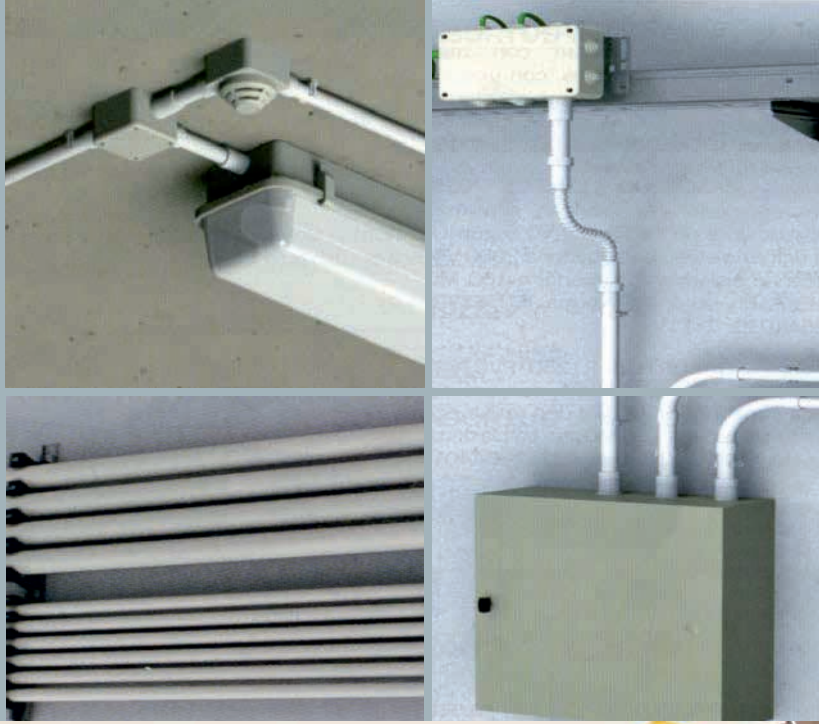

**E**LEKTRİK TESİSAT BORULARI  
ELECTRICAL INSTALLATION CONDUITS

  
**COMPASS** TRADING  
“Your COMPASS for Quality..”

ELEKTRİK TESİSAT BORULARI  
ELECTRICAL INSTALLATION CONDUITS



**PVC Düz Boru / PVC Rigid Conduit**  
Hafif Seri / Light Gauge

**Alev Yayımayan - Yayla Bükülebilir TesiSat Borusu**

DLX 801 Kullanım Alanları: Mekanik zorlamaların fazla olmadığı yerlerde, sıva altı ve sıva üstünde, alçıpan, duvar yada asma tavan içinde ve yükseltilmiş döşeme uygulamalarında.

**Self Extinguishing - Malleable Rigid Conduit**

**DLX 801 Field of Application:** Used in applications on walls, under the plaster; in all kinds of concrete floor and ceiling slabs, on suspended ceilings and under areas where low mechanical shocks and loadings are expected and also available for raised floor.

Renk Kod No  
Color Code



Siyah  
Black  
Ral 9005



Gri  
Grey  
Ral 7035



Beyaz  
White  
Ral 9016

PVC DÜZ BORU / PVC RIGID CONDUIT

Ürün Kodu Product Code	Dış Çap (mm) Ex. Diameter (mm)	İç Çap (mm) Int. Diameter (mm)	Ambalaj Packaging
DLX 801 16	Ø 16	13,6	102 m
DLX 801 20	Ø 20	17,4	102 m
DLX 801 25	Ø 25	22,1	51 m
DLX 801 32	Ø 32	28,6	45 m
DLX 801 40	Ø 40	36,7	30 m



**Teknik Özellikler**

Standart	: EN 61386-21 / 22
Malzeme	: PVC Bazlı Termoplastik
Sıkıştırma Dayanımı	: 320 Newton / 60 sn./sec / 23± 2°C
Darbe Dayanımı	: 1 kg. / 100 mm / -25°C
Çalışma Ortamı Sıcaklığı	: - 25°C + 60°C
Yalıtım Gerilimi	: 2000 V. / 50 Hz. / 15 dak.
Kendiliğinden Sönen PVC Malzeme	: UL94 V0
Boru Boyu	: 3 m.

**Technical Details**

Standard	: EN 61386-21 / 22
Material	: PVC Based Thermoplastic
Compression Resistance	: 320 Newton / 60 sn./sec / 23± 2°C
Impact Resistance	: 1 kg. / 100 mm / -25°C
Working Temperature	: - 25°C + 60°C
Insulating Strength	: 2000 V. / 50 Hz. / 15 min.
PVC Material (Self Extinguishing)	: UL94 V0
Conduit Length	: 3 m.



**ELEKTRİK TESİSAT BORULARI**  
**ELECTRICAL INSTALLATION CONDUITS**



**PVC Düz Boru / PVC Rigid Conduit**  
**Orta Seri / Medium Gauge**

**Alev Yayımayan - Yayla Bükülebilir Tesiilat Borusu**

DLX 802 Kullanım Alanları: Mekanik zorlamaların fazla olmadığı yerlerde, sıva altı ve sıva üstünde, alçıpan, duvar yada asma tavan içinde ve yükseltilmiş döşeme uygulamalarında.

**Self Extinguishing - Malleable Rigid Conduit**

**DLX 802 Field of Application:** Used in applications on walls, under the plaster; in all kinds of concrete floor and ceiling slabs, on suspended ceilings and under areas where low mechanical shocks and loadings are expected and also available for raised floor.

**Renk Kod No**  
**Color Code**



Siyah  
Black  
Ral 9005



Gri  
Grey  
Ral 7035



Beyaz  
White  
Ral 9016

**PVC DÜZ BORU / PVC RIGID CONDUIT**

Ürün Kodu Product Code	Dış Çap (mm) Ex. Diameter (mm)	İç Çap (mm) Int. Diameter (mm)	Ambalaj Packaging
DLX 802 16	Ø 16	13,1	102 m
DLX 802 20	Ø 20	16,9	102 m
DLX 802 25	Ø 25	21,6	51 m
DLX 802 32	Ø 32	27,8	45 m
DLX 802 40	Ø 40	35,6	30 m



**Teknik Özellikler**

Standart	: EN 61386-21 / 22
Malzeme	: PVC Bazlı Termoplastik
Sıkıştırma Dayanımı	: 750 Newton / 60 sn./sec / 23± 2°C
Darbe Dayanımı	: 1 kg. / 100 mm / -25°C
Çalışma Ortamı Sıcaklığı	: - 25°C + 60°C
Yalıtım Gerilimi	: 2000 V. / 50 Hz. / 15 dak.
Kendiliğinden Sönen PVC Malzeme	: UL94 V0
Boru Boyu	: 3 m.

**Technical Details**

Standard	: EN 61386-21 / 22
Material	: PVC Based Thermoplastic
Compression Resistance	: 750 Newton / 60 sn./sec / 23± 2°C
Impact Resistance	: 1 kg. / 100 mm / -25°C
Working Temperature	: - 25°C + 60°C
Insulating Strength	: 2000 V. / 50 Hz. / 15 min.
PVC Material (Self Extinguishing):	UL94 V0
Conduit Length	: 3 m.

ELEKTRİK TESİSAT BORULARI  
ELECTRICAL INSTALLATION CONDUITS



**Mufllu PVC Düz Boru / Sleeved PVC Rigid Conduit**  
**Hafif Seri / Light Gauge**

**Alev Yayımayan - Yayla Bükülebilen TesiSat Borusu**

DLX 804 Kullanım Alanları: Mekanik zorlamaların fazla olmadığı yerlerde, sıva altı ve sıva üstünde, alçıpan, duvar yada asma tavan içinde ve yükseltilmiş döşeme uygulamalarında.

**Self Extinguishing - Malleable Rigid Conduit**

**DLX 804 Field of Application:** Used in applications on walls, under the plaster; in all kinds of concrete floor and ceiling slabs, on suspended ceilings and under areas where low mechanical shocks and loadings are expected and also available for raised floor.

**Renk Kod No**  
**Color Code**



Siyah  
Black  
Ral 9005



Gri  
Grey  
Ral 7035



Beyaz  
White  
Ral 9016

**PVC DÜZ BORU / PVC RIGID CONDUIT**

Ürün Kodu Product Code	Dış Çap (mm) Ex. Diameter (mm)	İç Çap (mm) Int. Diameter (mm)	Ambalaj Packaging
DLX 804 16	Ø 16	13,6	102 m
DLX 804 20	Ø 20	17,4	102 m
DLX 804 25	Ø 25	22,1	51 m
DLX 804 32	Ø 32	28,6	45 m
DLX 804 40	Ø 40	36,7	30 m



**Teknik Özellikler**

Standart	: EN 61386-21 / 22
Malzeme	: PVC Bazlı Termoplastik
Sıkıştırma Dayanımı	: 320 Newton / 60 sn./sec / 23± 2°C
Darbe Dayanımı	: 1 kg. / 100 mm / -25°C
Çalışma Ortamı Sıcaklığı	: - 25°C + 60°C
Yalıtım Gerilimi	: 2000 V. / 50 Hz. / 15 dak.
Kendiliğinden Sönen PVC Malzeme	: UL94 V0
Boru Boyu	: 3 m.

**Technical Details**

Standard	: EN 61386-21 / 22
Material	: PVC Based Thermoplastic
Compression Resistance	: 320 Newton / 60 sn./sec / 23± 2°C
Impact Resistance	: 1 kg. / 100 mm / -25°C
Working Temperature	: - 25°C + 60°C
Insulating Strength	: 2000 V. / 50 Hz. / 15 min.
PVC Material (Self Extinguishing)	: UL94 V0
Conduit Length	: 3 m.

ELEKTRİK TESİSAT BORULARI  
ELECTRICAL INSTALLATION CONDUITS



**Muflu PVC Düz Boru / Sleeved PVC Rigid Conduit**  
Orta Seri / Medium Gauge

**Alev Yayımayan - Yayla Bükülebilir Tesiilat Borusu**

DLX 805 Kullanım Alanları: Mekanik zorlamaların fazla olmadığı yerlerde, sıva altı ve sıva üstünde, alçıpan, duvar yada asma tavan içinde ve yükseltilmiş döşeme uygulamalarında.

**Self Extinguishing - Malleable Rigid Conduit**

**DLX 805 Field of Application:** Used in applications on walls, under the plaster; in all kinds of concrete floor and ceiling slabs, on suspended ceilings and under areas where low mechanical shocks and loadings are expected and also available for raised floor.

Renk Kod No  
Color Code



Siyah  
Black  
Ral 9005



Gri  
Grey  
Ral 7035



Beyaz  
White  
Ral 9016

PVC DÜZ BORU / PVC RIGID CONDUIT

Ürün Kodu Product Code	Dış Çap (mm) Ex. Diameter (mm)	İç Çap (mm) Int. Diameter (mm)	Ambalaj Packaging
DLX 805 16	Ø 16	13,1	102 m
DLX 805 20	Ø 20	16,9	102 m
DLX 805 25	Ø 25	21,6	51 m
DLX 805 32	Ø 32	27,8	45 m
DLX 805 40	Ø 40	35,6	30 m



**Teknik Özellikler**

Standart	: EN 61386-21 / 22
Malzeme	: PVC Bazlı Termoplastik
Sıkıştırma Dayanımı	: 750 Newton / 60 sn./sec / 23± 2°C
Darbe Dayanımı	: 1 kg. / 100 mm / -25°C
Çalışma Ortamı Sıcaklığı	: - 25°C + 60°C
Yalıtım Gerilimi	: 2000 V. / 50 Hz. / 15 dak.
Kendiliğinden Sönen PVC Malzeme	: UL94 V0
Boru Boyu	: 3 m.

**Technical Details**

Standard	: EN 61386-21 / 22
Material	: PVC Based Thermoplastic
Compression Resistance	: 750 Newton / 60 sn./sec / 23± 2°C
Impact Resistance	: 1 kg. / 100 mm / -25°C
Working Temperature	: - 25°C + 60°C
Insulating Strength	: 2000 V. / 50 Hz. / 15 min.
PVC Material (Self Extinguishing):	UL94 V0
Conduit Length	: 3 m.

## DÜZ BORU BAĞLANTI AKSESUARLARI CONDUIT INSTALLATIONS ACCESSORIES

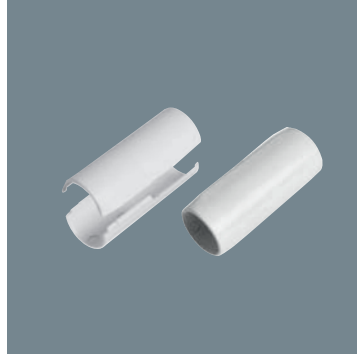

### Ek Mufu / Coupling

Ürün Kodu Product Code	Çap Diameter	Ambalaj Packaging
DLX 811 16	Ø 16	100 Ad./Pcs.
DLX 811 20	Ø 20	100 Ad./Pcs.
DLX 811 25	Ø 25	100 Ad./Pcs.
DLX 811 32	Ø 32	100 Ad./Pcs.



### 90° Dirsek / 90° Elbow

Ürün Kodu Product Code	Çap Diameter	Ambalaj Packaging
DLX 821 16	Ø 16	100 Ad./Pcs.
DLX 821 20	Ø 20	100 Ad./Pcs.
DLX 821 25	Ø 25	100 Ad./Pcs.
DLX 821 32	Ø 32	100 Ad./Pcs.



### T Eki / T Corner

Ürün Kodu Product Code	Çap Diameter	Ambalaj Packaging
DLX 831 16	Ø 16	100 Ad./Pcs.
DLX 831 20	Ø 20	100 Ad./Pcs.
DLX 831 25	Ø 25	100 Ad./Pcs.
DLX 831 32	Ø 32	100 Ad./Pcs.

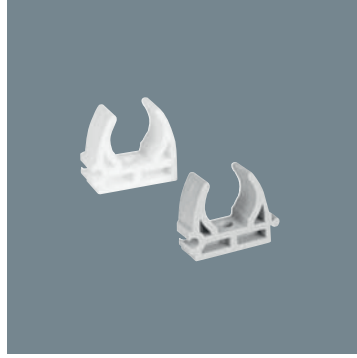

### Ay Kroşe / Snap Clip

Ürün Kodu Product Code	Çap Diameter	Ambalaj Packaging
DLX 841 16	Ø 16	500 Ad./Pcs.
DLX 841 20	Ø 20	500 Ad./Pcs.
DLX 841 25	Ø 25	500 Ad./Pcs.
DLX 841 32	Ø 32	500 Ad./Pcs.



### PVC Düz Boru Rakoru PVC Rigid Pipe Adapter

Ürün Kodu Product Code	Çap Diameter	Ambalaj Packaging
DLX 875 16	Ø 16	100 Ad./Pcs.
DLX 875 20	Ø 20	100 Ad./Pcs.
DLX 875 25	Ø 25	100 Ad./Pcs.
DLX 875 32	Ø 32	100 Ad./Pcs.



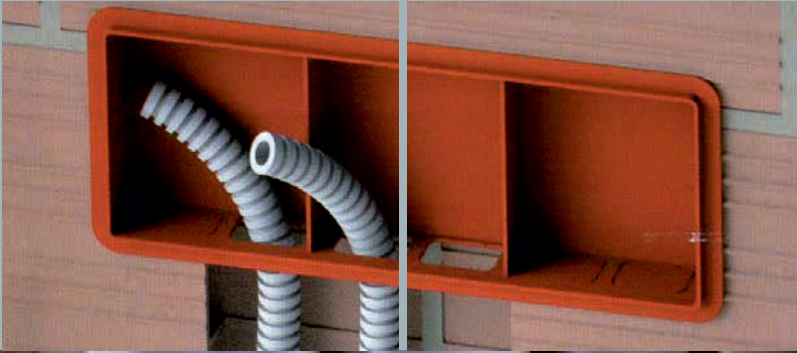
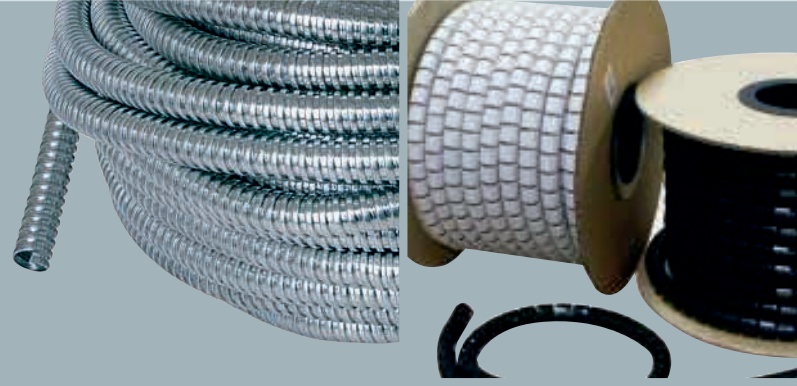

**E**LEKTRİK SİRİRAL BORULARI  
ELECTRICAL INSTALLATION  
CORRUGATED CONDUITS

## ELEKTRİK TESİSAT BORULARI ELECTRICAL INSTALLATION CONDUITS



### PE Spiral Boru PE Corrugated Conduit

#### Halojensiz

**DLX 840 Kullanım Alanları:** Her türlü elektrik tesisatında mekanik zorlamaların fazla olmadığı yerlerde, bina, prefabrik yapılarda, sıva altı ve sıva üstü tüm uygulamalarda, beton içerisinde, alçıpan, duvar ya da asma tavan içerisinde, özellikle tünel kalıp sistemlerinde ve yükseltilmiş döşeme uygulamalarında.

#### Halogen free

**DLX 840 Field of Application:** Used in applications on walls, under the plaster; in all kinds of concrete floor and ceiling slabs, on suspended ceilings and under areas where low mechanical shocks and loadings are expected and also available for raised floor.

#### Renk Kod No / Color Code



Siyah  
Black  
Ral 9005



Gri  
Grey  
Ral 7035



Mavi  
Blue  
Ral 5017



Turuncu  
Orange  
Ral 2004



Beyaz  
White  
Ral 9016

#### PE SİRİRAL BORU / PE CORRUGATED CONDUIT

Ürün Kodu Product Code	Dış Çap (mm) Ex. Diameter (mm)	İç Çap (mm) Int. Diameter (mm)	Ambalaj / m Package / m
DLX 840 16	Ø 16	11,2	100
DLX 840 20	Ø 20	14,5	100
DLX 840 25	Ø 25	19,0	50
DLX 840 32	Ø 32	24,8	50
DLX 840 40	Ø 40	32,20	25

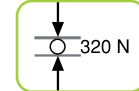

#### Teknik Özellikler

Standart	: EN 61386-21 / 22
Malzeme	: PE Bazlı Termoplastik
Sıkıştırma Dayanımı	: 320 Newton / 60 sn./sec / 23± 2°C
Darbe Dayanımı	: 2 kg. / 100 mm / -25°C
Çalışma Ortamı Sıcaklığı	: - 25°C + 60°C
Yalıtım Gerilimi	: 2000 V. / 50 Hz. / 15 dak.

#### Technical Details

Standard	: EN 61386-21 / 22
Material	: PE Based Thermoplastic
Compression Resistance	: 320 Newton / 60 sn./sec / 23± 2°C
Impact Resistance	: 2 kg. / 100 mm / -25°C
Working Temperature	: - 25°C + 60°C
Insulating Strength	: 2000 V. / 50 Hz. / 15 min.

ELEKTRİK TESİSAT BORULARI  
ELECTRICAL INSTALLATION CONDUITS



**PP Spiral Boru**  
**PP Corrugated Conduit**

**Halojensiz Alev Yayımayan**

**DLX 860 Kullanım Alanları:** Her türlü elektrik tesisatında mekanik zorlamaların fazla olmadığı yerlerde, bina, prefabrik yapılarda, sıva altı ve sıva üstü tüm uygulamalarda, beton içerisinde, alçıpan, duvar ya da asma tavan içerisinde, özellikle tünel kalıp sistemlerinde ve yükseltilmiş döşeme uygulamalarında.

**Self Extinguishing Halogen free**

**DLX 860 Field of Application:** Used in applications on walls, under the plaster; in all kinds of concrete floor and ceiling slabs, on suspended ceilings and under areas where low mechanical shocks and loadings are expected and also available for raised floor.

Renk Kod No / Color Code



Siyah  
Black  
Ral 9005



Gri  
Grey  
Ral 7035



Mavi  
Blue  
Ral 5017



Beyaz  
White  
Ral 9016

PP SİRİAL BORU / PP CORRUGATED CONDUIT

Ürün Kodu Product Code	Dış Çap (mm) Ex. Diameter (mm)	İç Çap (mm) Int. Diameter (mm)	Ambalaj / m Package / m
DLX 860 16	Ø 16	11,2	100
DLX 860 20	Ø 20	14,5	100
DLX 860 25	Ø 25	19,0	50
DLX 860 32	Ø 32	24,8	50
DLX 860 40	Ø 40	32,20	25



**Teknik Özellikler**

Standart	: EN 61386-21 / 22
Malzeme	: PP Bazlı Termoplastik
Sıkıştırma Dayanımı	: 320 Newton / 60 sn./sec / 23± 2°C
Darbe Dayanımı	: 2 kg. / 100 mm / -25°C
Çalışma Ortamı Sıcaklığı	: - 25°C + 60°C
Yalıtım Gerilimi	: 2000 V. / 50 Hz. / 15 dak.

**Technical Details**

Standard	: EN 61386-21 / 22
Material	: PP Based Thermoplastic
Compression Resistance	: 320 Newton / 60 sn./sec / 23± 2°C
Impact Resistance	: 2 kg. / 100 mm / -25°C
Working Temperature	: - 25°C + 60°C
Insulating Strength	: 2000 V. / 50 Hz. / 15 min.

## ELEKTRİK TESİSAT BORULARI ELECTRICAL INSTALLATION CONDUITS



### PE Spiral Boru Klavuz Telli PE Corrugated Conduit the guide wire

#### Halojensiz

**DLX 849 Kullanım Alanları:** Her türlü elektrik tesisatında mekanik zorlamaların fazla olmadığı yerlerde, bina, prefabrik yapılarda, sıva altı ve sıva üstü tüm uygulamalarda, beton içerisinde, alçıpan, duvar ya da asma tavan içerisinde, özellikle tünel kalıp sistemlerinde ve yükseltilmiş döşeme uygulamalarında.

#### Halogen free

**DLX 849 Field of Application:** Used in applications on walls, under the plaster; in all kinds of concrete floor and ceiling slabs, on suspended ceilings and under areas where low mechanical shocks and loadings are expected and also available for raised floor.

#### Renk Kod No / Color Code

				
Siyah Black Ral 9005	Gri Grey Ral 7035	Mavi Blue Ral 5017	Turuncu Orange Ral 2004	Beyaz White Ral 9016



#### PE SİRİRAL BORU / PE CORRUGATED CONDUIT

Ürün Kodu Product Code	Dış Çap (mm) Ex. Diameter (mm)	İç Çap (mm) Int. Diameter (mm)	Ambalaj / m Package / m
DLX 849 16	Ø 16	11,2	100
DLX 849 20	Ø 20	14,5	100
DLX 849 25	Ø 25	19,0	50
DLX 849 32	Ø 32	24,8	50
DLX 849 40	Ø 40	32,20	25



#### Teknik Özellikler

Standart	: EN 61386-21 / 22
Malzeme	: PE Bazlı Termoplastik
Sıkıştırma Dayanımı	: 320 Newton / 60 sn./sec / 23± 2°C
Darbe Dayanımı	: 2 kg. / 100 mm / -25°C
Çalışma Ortamı Sıcaklığı	: - 25°C + 60°C
Yalıtım Gerilimi	: 2000 V. / 50 Hz. / 15 dak.

#### Technical Details

Standard	: EN 61386-21 / 22
Material	: PE Based Thermoplastic
Compression Resistance	: 320 Newton / 60 sn./sec / 23± 2°C
Impact Resistance	: 2 kg. / 100 mm / -25°C
Working Temperature	: - 25°C + 60°C
Insulating Strength	: 2000 V. / 50 Hz. / 15 min.



## ELEKTRİK TESİSAT BORULARI ELECTRICAL INSTALLATION CONDUITS



DLX 869

### Renk Kod No / Color Code



Siyah  
Black  
Ral 9005



Gri  
Grey  
Ral 7035



Mavi  
Blue  
Ral 5017



Beyaz  
White  
Ral 9016

## PP Spiral Boru Klavuz Telli PP Corrugated Conduit the guide wire

### Halojeniz Alev Yayımayan

**DLX 869 Kullanım Alanları:** Her türlü elektrik tesisatında mekanik zorlamaların fazla olmadığı yerlerde, bina, prefabrik yapılarda, sıva altı ve sıva üstü tüm uygulamalarda, beton içerisinde, alçıpan, duvar ya da asma tavan içerisinde, özellikle tünel kalıp sistemlerinde ve yükseltilmiş döşeme uygulamalarında.

### Self Extinguishing Halogen free

**DLX 869 Field of Application:** Used in applications on walls, under the plaster; in all kinds of concrete floor and ceiling slabs, on suspended ceilings and under areas where low mechanical shocks and loadings are expected and also available for raised floor.



### PP SPIRAL BORU / PP CORRUGATED CONDUIT

Ürün Kodu Product Code	Dış Çap (mm) Ex. Diameter (mm)	İç Çap (mm) Int. Diameter (mm)	Ambalaj / m Package / m
DLX 869 16	Ø 16	11,2	100
DLX 869 20	Ø 20	14,5	100
DLX 869 25	Ø 25	19,0	50
DLX 869 32	Ø 32	24,8	50
DLX 869 40	Ø 40	32,20	25

### Teknik Özellikler

Standart	: EN 61386-21 / 22
Malzeme	: PP Bazlı Termoplastik
Sıkıştırma Dayanımı	: 320 Newton / 60 sn./sec / 23± 2°C
Darbe Dayanımı	: 2 kg. / 100 mm / -25°C
Çalışma Ortamı Sıcaklığı:	- 25°C + 60°C
Yalıtım Gerilimi	: 2000 V. / 50 Hz. / 15 dak.

### Technical Details

Standard	: EN 61386-21 / 22
Material	: PP Based Thermoplastic
Compression Resistance	: 320 Newton / 60 sn./sec / 23± 2°C
Impact Resistance	: 2 kg. / 100 mm / -25°C
Working Temperature	: - 25°C + 60°C
Insulating Strength	: 2000 V. / 50 Hz. / 15 min.

ELEKTRİK TESİSAT BORU AKSESUARLARI  
ELECTRICAL INSTALLATION CONDUIT ACCESSORIES



**Spiral Boru Rakoru**  
**Spiral Pipe Adapter**

Ürün Kodu Product Code	Dış Çap (mm) Ex. Diameter (mm)	İç Çap (mm) Int. Diameter (mm)	Ambalaj / adet Packaging / pcs
DLX 878 16	2,5	10,0-14,0	100
DLX 878 20	3,0	15,0-19,0	100
DLX 878 25	4,4	21,0-25,0	100
DLX 878 32	1,0	28,3-32,3	100

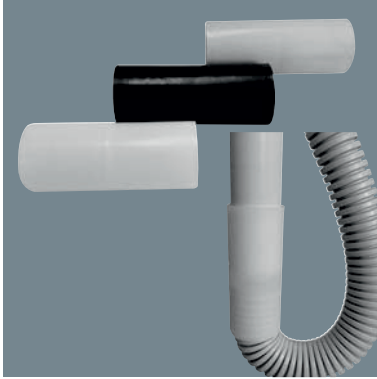

**Spiral Boru Mufu**  
**Spiral Pipe Coupling**

Ürün Kodu Product Code	Dış Çap (mm) Ex. Diameter (mm)	İç Çap (mm) Int. Diameter (mm)	Ambalaj / adet Packaging / pcs
DLX 876 16	1,5	16,4	100
DLX 876 20	1,5	20,5	100
DLX 876 25	2	25,5	100
DLX 876 32	2	32,5	100
DLX 876 40	2	41	100



**Kablo Toplama Spirali**  
**Spiral Cable Wrap**

Ürün Kodu Product Code	İç Çap (mm) Int. Diameter (mm)	Ambalaj / adet Packaging / pcs
DLX 877 30	20 (1,5mt)	1
DLX 877 31	25 (1,5mt)	1
DLX 877 32	30 (1,5mt)	1
DLX 877 33	Aksesuar (20mm)	1



**Kablo Toplama Spirali**  
**Spiral Cable Wrap**

Ürün Kodu Product Code	İç Çap (mm) Int. Diameter (mm)	Ambalaj / m Packaging / m
DLX 877 22	20	25
DLX 877 28	25	20
DLX 877 29	30	15

## KABLO KANAL DÜBELLERİ CABLE TRUNKING SCREW SOCKETS



910 10

**Kablo Kanalı Dübeli**  
Cable Trunking Screw Socket  
Ambalaj: 500 Adet  
Packaging: 500m



910 11

**Alıçipan dübeli**  
Screwed Plaster  
Ambalaj: 500 Adet  
Packaging: 500m



910 12

**Dübel 7mm**  
Screw Socket  
Ambalaj: 1000 Adet  
Packaging: 1000m



910 13

**Dübel 8mm**  
Screw Socket  
Ambalaj: 1000 Adet  
Packaging: 1000pcs



910 14

**Kablo kanalı Vidası  
5x40mm**  
Cable Trunking Screw 5x40mm  
Ambalaj: 144 Adet  
Packaging: 144 pcs



910 15

**Kablo kanalı Vidası  
5x50mm**  
Cable Trunking Screw 5x50mm  
Ambalaj: 144 Adet  
Packaging: 144 pcs



910 16

**Kablo kanalı pulu  
3x16 mm**  
Cable Trunking Screw Washer  
Ambalaj: 500 Adet  
Packaging: 500pcs



## ÇELİK SİRALLER STEEL TUBES

### ÇELİK SİRALLER / STEEL TUBES

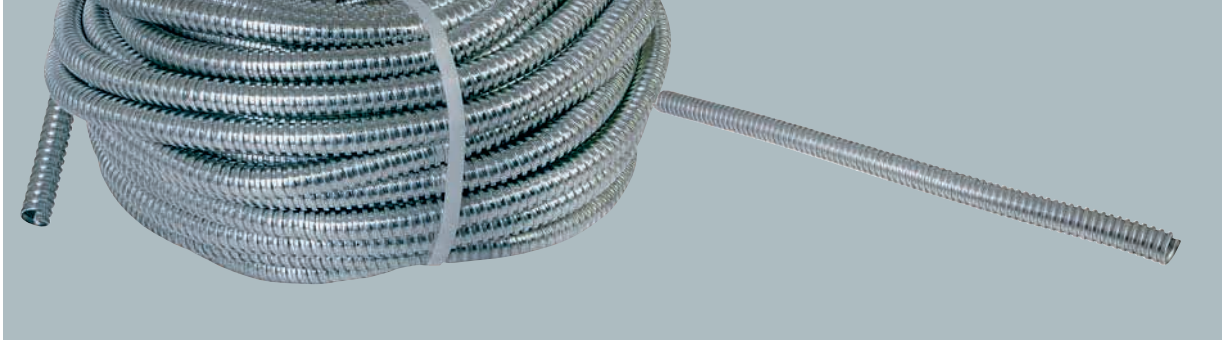

Ürün Kodu Product Code	Nominal Çap Nominal Diameter	İç Çap (mm) Int. Diameter (mm)	Dış Çap (mm) Ex. Diameter (mm)	Ambalaj / adet Packaging / pcs
871 09	Ø 9	9	11,5	50 m
871 11	Ø 11	11	14	50 m
871 14	Ø 14	14	17	50 m
871 16	Ø 16	16	19	50 m
871 18	Ø 18	18	21	25 m
871 26	Ø 26	26	29	25 m
871 29	Ø 29	29	32	25 m
871 37	Ø 37	37	41	25 m
871 40	Ø 40	40	48	25 m
871 50	Ø 50	50	55	25 m

- Hammadde: Kalaylı Çelik • Çalışma Sıcaklığı : -25° +150°
- Material : Tin-Coated Steel • Working Temperature: -25° +150°

### PVC KAPLI ÇELİK SİRALLER / PVC COATED STEEL TUBES



Ürün Kodu Product Code	Nominal Çap Nominal Diameter	İç Çap (mm) Int. Diameter (mm)	Dış Çap (mm) Ex. Diameter (mm)	Ambalaj / adet Packaging / pcs
873 09	Ø 9	9	11,5	50 m
873 11	Ø 11	11	14	50 m
873 14	Ø 14	14	17	50 m
873 16	Ø 16	16	19	50 m
873 18	Ø 18	18	21	50 m
873 26	Ø 26	26	29	25 m
873 29	Ø 29	29	32	25 m
873 37	Ø 37	37	41	25 m
873 40	Ø 40	40	48	25 m
873 50	Ø 50	50	55	25 m

- Hammadde: Kaylı Çelik + Termo plastik PVC • Çalışma Sıcaklığı : -25° +80°
- Material : Tin-Coated Steel + Termo plastic PVC • Working Temperature: -25° +80°



**GALVANİZLİ ÇELİK SİRALLER**  
**GALVENISED STEEL TUBE**

**GALVANİZLİ ÇELİK SİRALLER / GALVENISED STEEL TUBES**

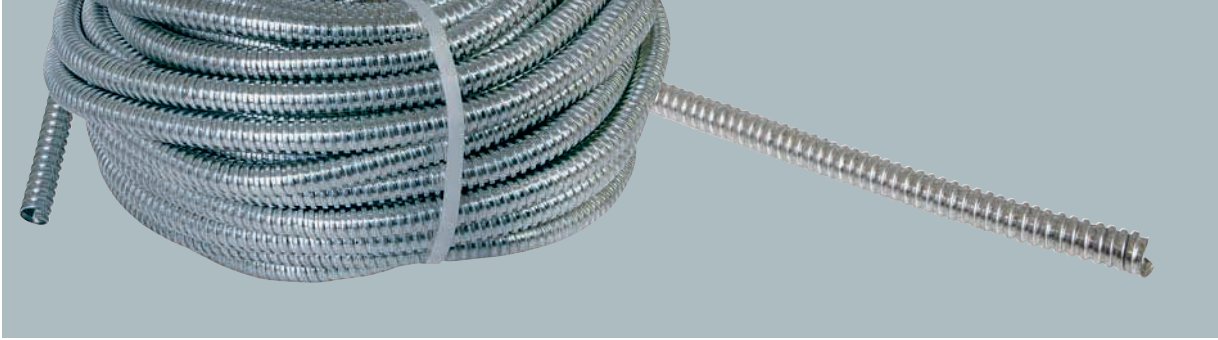

Ürün Kodu Product Code	Nominal Çap Nominal Diameter	İç Çap (mm) Int. Diameter (mm)	Dış Çap (mm) Ex. Diameter (mm)	Ambalaj / adet Packaging / pcs
872 09	Ø 9	9	11,5	50 m
872 11	Ø 11	11	14	50 m
872 14	Ø 14	14	17	50 m
872 16	Ø 16	16	19	50 m
872 18	Ø 18	18	21	50 m
872 26	Ø 26	26	29	25 m
873 29	Ø 29	29	32	25 m
872 37	Ø 37	37	41	25 m
872 40	Ø 40	40	48	25 m
872 50	Ø 50	50	55	25 m

- Hammedde: Kalaylı Çelik • Çalışma Sıcaklığı : -25° +150°
- Material : Tin-Coated Steel • Working Temperature: -25° +150°

**PVC KAPLI GALVANİZLİ ÇELİK SİRALLER / PVC COATED GALVENISED STEEL TUBES**

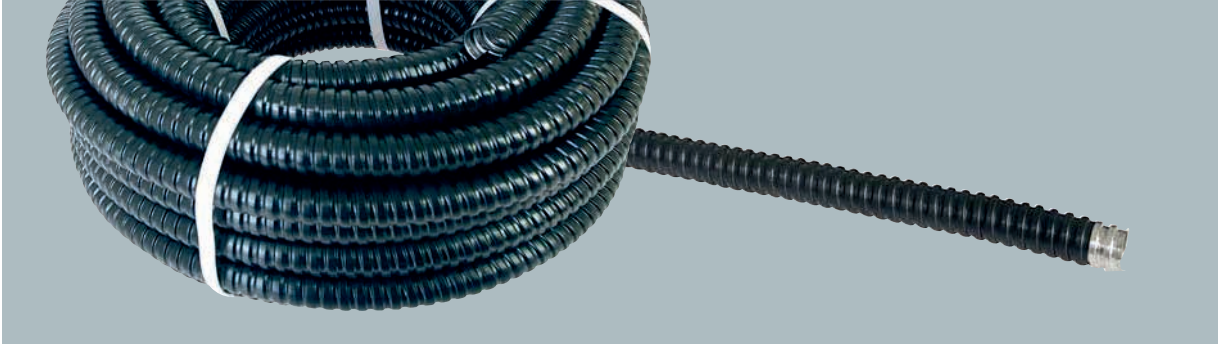

Ürün Kodu Product Code	Nominal Çap Nominal Diameter	İç Çap (mm) Int. Diameter (mm)	Dış Çap (mm) Ex. Diameter (mm)	Ambalaj / adet Packaging / pcs
874 09	Ø 9	9	11,5	50 m
874 11	Ø 11	11	14	50 m
874 14	Ø 14	14	17	50 m
874 16	Ø 16	16	19	50 m
874 18	Ø 18	18	21	50 m
874 26	Ø 26	26	29	25 m
874 29	Ø 29	29	32	25 m
874 37	Ø 37	37	41	25 m
874 40	Ø 40	40	48	25 m
874 50	Ø 50	50	55	25 m

- Hammedde: Kaylı Çelik + Termo plastik PVC • Çalışma Sıcaklığı : -25° +80°
- Material : Tin-Coated Steel + Termo plastic PVC • Working Temperature: -25° +80°

## ÇELİK SPİRALLER STEEL TUBES

### LIQUID TIGHT GALVANİZLİ ÇELİK SPİRAL LIQUID TIGHT GALVANIZED STEEL TUBES



Ürün Kodu Product Code	Nominal Çap Nominal Diameter	İç Çap (mm) Int. Diameter (mm)	Dış Çap (mm) Ex. Diameter (mm)	Ambalaj / adet Packaging / pcs
876 10	Ø 10	1/4" Ø10	14	30 m
876 13	Ø 13	3/8" Ø13	17	30 m
876 16	Ø 16	1/2" Ø16	21	30 m
876 21	Ø 21	3/4" Ø21	26	30 m
876 26	Ø 26	1" Ø26	32	30 m
876 35	Ø 35	1 1/4" Ø35	41	15 m
876 40	Ø 40	1 1/2" Ø40	47	15 m
876 52	Ø 52	2" Ø52	59	15 m
876 63	Ø 63	2 1/2" Ø63	72	15 m
876 78	Ø 78	3" Ø78	88	7.5 m
876 12	Ø 102	4" Ø102	112	7.5 m

### HALOJEN FREE PLASTİK KAPLI ÇELİK SPİRAL HALOGEN FREE PLASTIC COATED STEEL TUBES

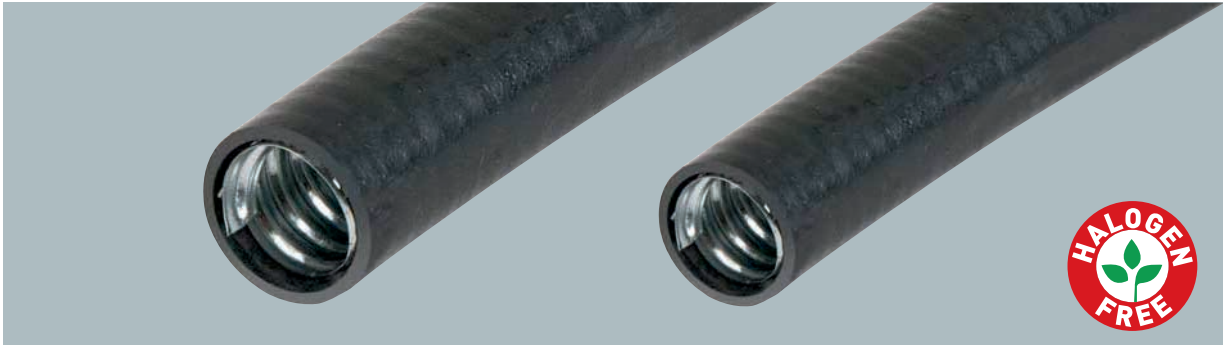

Ürün Kodu Product Code	Nominal Çap Nominal Diameter	İç Çap (mm) Int. Diameter (mm)	Dış Çap (mm) Ex. Diameter (mm)	Ambalaj / adet Packaging / pcs
877 09	Ø 9	9	11,5	50 m
877 11	Ø 11	11	14	50 m
877 14	Ø 14	14	17	50 m
877 16	Ø 16	16	19	50 m
877 18	Ø 18	18	21	50 m
877 26	Ø 26	26	29	25 m
877 29	Ø 29	29	32	25 m
877 37	Ø 37	37	41	25 m
877 40	Ø 40	40	48	25 m
877 50	Ø 50	50	55	25 m
877 63	Ø 63	63	70	25 m

CAM ELYAF TAKVİYELİ ELEKTRİK DAĞITIM PANOSU  
GLASS REINFORCED POLYESTER ELECTRICAL DISTRIBUTION BOARD



Ref:310 08  
600x800x220



Ref:310 07  
500x700x200



Ref:310 06  
400x600x200



Ref:310 05  
350x500x170



Ref:310 04  
300x400x170



Ref:310 02  
250x300x170



Ref:310 01  
200x300x120

**KİLİT SEÇENEKLERİ**

LOCK OPTIONS



Pako Kilit  
Paco Lock



Asma Kilit Hamili  
Çeyrek Dönüslü Kilit  
Padlockable  
Quarter Turn With Spring  
Wing Knob



Silindirik  
Kelebek Kilit  
Cam Lock-Wing  
Knob



Yaylı Pano Kilidi  
Kelebek (Metal Klipsli)  
Quarter Turn  
With Wing Knob  
(Metal Clip)



Yaylı Pano Kilidi (Plastik Üçgen)  
Quarter Turn With Spring  
(Plastic Triangular)

**Standart Kilit Sistemi**  
**Standard Locking System**

## CAM ELYAF TAKVİYELİ ELEKTRİK DAĞITIM PANOSU GLASS REINFORCED POLYESTER ELECTRICAL DISTRIBUTION BOARD



### GENEL ÖZELLİKLER COMMON SPECIFICATION

- ✓ Paslanmaz, çizilmez, boya bakım gerektirmez.
- ✓ Elektrik iletmez, yalıtkandır.
- ✓ Alev iletmez ve kendiliğinden söner.
- ✓ Rutubet, nem barındırmaz.
- ✓ Atmosferik şartlara karşı dayanıklıdır.
- ✓ Üzerine logo istenildiği gibi yapılabilir.
- ✓ Rustproof, unscratcheble paint, no need painting & maintenance.
- ✓ Dielectric.
- ✓ Flameproof, self-extinguishing.
- ✓ Non-affected by humidity.
- ✓ Resistant to atmosphere conditions.
- ✓ Your logo can be placed on.

### TEKNİK ÖZELLİKLER TECHNICAL SPECIFICATION

Ham madde	: Cam Elyaf Takviyeli Polyester	Raw Material	: Glass Reinforced Polyester
Kalite Standardı	: EN61439, EN60670-1	Quality Standart	: EN61439, EN60670-1
Renk	: RAL 7035 (Renk Seçenekleri vardır)	Color	: RAL 7035 (There are color options)
Çalışma Sıcaklığı	: -40°+70°C	Operating Temperature	: -40°+70°C
Kapak Açılma Açısı	: 210	Door Opening Angle	: 210
Menteşe	: 2/3 Adet	Hinge	: 2/3 Pieces
Kilit	: 1/2 Adet	Lock	: 1/2 Pieces
Kilit Seçenekleri	: Üçgen, Kelebek, Yaylı, Sıkıştırılmalı (metal veya plastik)	Lock Options	: Triangle, Butterfly, Springy, Compression (Metal or Plastic)
Koruma Kılıfı	: IP 54 / IP65	Protection Class	: IP 54 / IP65
Yangın Dayanımı	: B2 (İstenildiğinde A1, A2, B1, V0)	Fire Resistance	: B2 (Can change to A1, A2, B1, V0)
UV Dayanımı	: Talebe göre eklenebilir	UV Resistance	: Can be added acc.to request
Nem Dayanımı	: Evet	Humidity Resistance	: Yes
Kimyasal Dayanımı	: Asit ve Bazlara Karşı Tam Koruma	Chemical Resistance	: Full Protection Against acid and base
Aşınma Dayanımı	: Olumsuz hava koşullarına karşı yüksek dayanım	Corrosion Resistance	: High Resistance Against adverse weather conditions
Conta	: Poliüretan dökme conta veya EPDM conta	Gasket	: Polyurathane foam gasket or EPDM gasket
Topraklama Sınıfı	: Class II	Grounding Class	: Class II





Yetkili Satıcı  
Distributed by

© COPYRIGHT 01.01.2013



Compass Yapı Malz. İth. İhr. ve San. LTD STİ.  
M. Akif Ersoy Mah. 2013. Sk. No:39 / 9  
Esenyurt - İstanbul / TURKEY

[www.compass-trading.net](http://www.compass-trading.net)

/

[sales@compass-trading.net](mailto:sales@compass-trading.net)

